



**Dynamo Hockey
Service Manual and Instructions**



7115 Belton St.
Richland Hills, TX 76118
817.284.3499

sales@valley-dynamo.com

For International Sales:
international@valley-dynamo.com

See the full Valley Dynamo product line at
www.builtbyplayers4players.com

VD/AdTemp_Rev02/2013





Contents

- 3 – Warranty**
- 6 – Declaration of Conformity**
- 7 – Warnings and notices**
- 8 – Basic assembly instructions**
- 10 – Side Shield Installation**
- 11 – Rules of Play**
- 13 – Routine Maintenance**
- 15 – Operation and Programming**
- 17 – Program Configuration – v7.01** (no sound)
- 18 – Program Configuration – v9.0** (tables w/sound)
- 20 – Exploded Diagram of table**
- 21 – Table Parts Listing**
- 23 – Overhead Parts Listing**
- 24 – PCB Identification**
- 27 – Troubleshooting Flowcharts**
- 36 – Closing Notes**



Warranty Details

Valley-Dynamo warrants its new products to be free from defects resulting from faulty manufacture or faulty components under the following terms and conditions:

WARRANTY LENGTH

One year on Dynamo® Hockey tables. **90 days** on Replacement Parts

FOR WARRANTY SERVICE

Valley-Dynamo will, at its sole option, repair, upgrade or replace this product in the event of any defect in materials or workmanship during the warranty period. This shall be Valley-Dynamo's sole obligation, and the customer's sole remedy, for any warranty claim.

Valley-Dynamo will request and you must provide the **complete Model Number & Serial Number of the unit** (not just the last 5 digits), or other proof of purchase such as an invoice or receipt.

OPERATORS AND END USERS – While our Tech Support staff is available to assist with diagnosis and troubleshooting of your problem, contact your Distributor for Warranty Service on your equipment.

DEALERS AND DISTRIBUTORS – To obtain replacement and an RMA number, contact Valley-Dynamo referencing the Model number and Serial number of the unit and the nature of the problem. Valley-Dynamo will, at its discretion, send replacement parts and/or issue an RMA for the return of

failed parts. To avoid billing issues, request an RMA when the failed part is present or readily available. Credit will be issued only upon receipt and inspection of the RMA. Valley-Dynamo may send replacement parts or issue an account credit. NO REFUNDS. Valley-Dynamo reserves the right to cancel outstanding RMAs 30 days after issue. Items returned without an RMA will not be inspected or credited and may be refused or returned at Customer Expense.

REPLACEMENT PARTS COVERAGE – Valley-Dynamo warrants replacement parts for 90 days from the date of purchase. To obtain a replacement and an RMA number, contact Valley-Dynamo referencing the nature of the problem and provide proof of purchase. Valley-Dynamo will, at its discretion, send replacement parts and/or issue an RMA for the return of failed parts. To avoid billing issues, request an RMA when the failed part is present or readily available. Upon receipt and inspection of the RMA, Valley-Dynamo may send replacement parts or issue an account credit. NO REFUNDS. Valley-Dynamo reserves the right to cancel outstanding RMAs 30 days after issue. Items returned without an RMA will not be inspected or credited and may be refused or returned at Customer Expense.

SCOPE OF COVERAGE

Note that our warranty is not an unconditional guarantee for the duration. Dynamo products are made to our exacting standards and known for their durability, but are not indestructible and may require periodic maintenance in order to function properly. The following are not covered by the warranty.

- 1) Shipping or transport damage
- 2) Normal wear and tear
- 3) Damage or deterioration resulting from neglect, misuse, accident, liquid spills, improper installation, abuse, pets, burns or mishandling

Hockey Playfields - *The most frequent cause of warpage or laminate separation on a playfield is a liquid spill. Liquid spills are not a covered warranty failure. If warranty failure is suspected, for evaluation Valley-Dynamo will require return of the damaged playfield or at minimum at least 12 square feet (4' x 3') of the damaged section. No credit will be issued for a Playfield damaged by a liquid spill, or for incoming or outgoing freight for the replacement or returned playfield.*

- 4) Incidental or consequential damage (except at Valley-Dynamo's discretion).
- 5) Removal or installation charges.

- 6) Shipping charges except at Valley-Dynamo's discretion.
- 7) Unauthorized modification of the product.
- 8) Use of this product with unapproved parts, conversion kits or accessories.
- 9) Damage from fire, flood, lightning or other acts of nature

EXCLUSION OF DAMAGES

Valley-Dynamo's sole obligation and liability under this warranty is limited to the repair or replacement of a defective product at our option. Valley-Dynamo shall not, in any event, be liable for any incidental or consequential damages resulting from interruption of service, loss of business or revenue, or for liability in tort relating to this product or resulting from its use or possession.

LIMITATIONS OF IMPLIED WARRANTIES

There are no other warranties, expressed or implied, including but not limited to those of merchantability, revenue generation, or fitness for a particular purpose. The duration of implied warranties is limited to the period specified in the Warranty Length section above.

TO OBTAIN TECHNICAL SUPPORT

Please check the resources available at www.valleydynamoparts.com or contact TECHHELP@valley-dynamo.com.

DECLARATION OF CONFORMITY

Dynamo, Ltd.

2525 Handley-Ederville Rd., Richland Hills, TX 76118

declare under our sole responsibility that the product

DH-100

to which this declaration relates is in conformity with the following standard(s) or other normative document(s)

- ◆ EN 55022, Class B, Limits and methods of measurement of radio interference characteristics of information technology equipment, 1992.
- ◆ EN 50082-1, Electromagnetic compatibility - Generic immunity standard -- Part 1: Residential, commercial, and light industry, January 1992.

following the provisions of The Electromagnetic Compatibility Directive, 89/33/EEC.

Richland Hills, TX

Place of Issuance
November 17, 1995

Date of Issuance

William G. Rickett

Printed Name

Signature of Authorized Person



Warnings and Notices

USE OF NON-DYNAMO PARTS OR CIRCUIT MODIFICATIONS MAY CAUSE SERIOUS INJURY OR EQUIPMENT DAMAGE! USE ONLY GENUINE DYNAMO AUTHORIZED PARTS.

- For safety and reliability, substitute parts and modifications are not recommended.
- Substitute parts or modifications may void FCC type acceptance.
- Use only authorized components and parts. Failure to do so will void warranty and may result in incorrect and/or unsafe operation.

WARNING

- Plug this game into a properly grounded outlet to prevent shock hazards and assure proper game operation.
- Do not use an adapter plug to defeat the power cord's grounding pin.
- Do not cut off ground pin.

Information in this manual is subject to change without notice. Dynamo reserves the right to make improvements in the equipment function, design or components as process in the engineering or manufacturing methods may warrant.

FOR GENUINE DYNAMO PARTS AND SERVICE CONTACT YOUR LOCAL AUTHORIZED DYNAMO DISTRIBUTOR.

PARTS CAN ALSO BE ORDERED AT WWW.VALLEYDYNAMOPARTS.COM



Assembly Instructions

Congratulations on purchasing a Dynamo Hockey table - the finest professional grade hockey table on the market.

BE SAFE: it is strongly recommended that you have at least two people involved in the setup of our hockey tables.

Lay the box flat on the floor, mindful of the section labeled "This Side Up." Cut the banding straps and remove the top portion of the box completely. Lower the sides of the box bottom by cutting or tearing vertically at all of the corners.

Open the coin door and remove the cash box lid, and the cash box with its contents.
The keys to open the coin door are found with the instruction manual, taped to the playfield protective pad.

The hockey table should now be carefully lifted onto its side (the coin housing assembly is on the opposite side, and will be pointing towards the ceiling when the table has been lifted). This procedure should be accomplished by two people tilting the table from the ends, **not lifting from one side. The table could land on you and cause injury if you lose your grip while lifting the table from its side.**

Removal of the legs and set up.

1. Using a #106 key, open the trapdoor on the bottom of the table.
2. Using a ½" socket or wrench, remove the bolt and woodblock that secures the legs during shipping.
3. Pull the legs on the right side out of their holding bracket and then push them up at a 45-degree angle. Then pull one leg out at a time from the left side. Next remove both right legs. This step is necessary due to the blower motor.
4. Replace the wooden block and bolt that secured the legs for future use.
5. Replace the trap door and lock it.
6. Bolt the legs onto the bottom of the table using a ½" socket wrench or straight slot screw driver.

7. Screw the leg leveler completely into the legs and turn the table upright.
8. Position and level the table, using an adjustable wrench.

For removal and storage of the legs follow steps 1-6 in reverse order.

Fire Storm and Short Shot tables include side shields. They can be found inside the box with the table. Side Shields are available as an accessory for all Dynamo coin and Pro Style tables. Install the shields at this time if needed.

If your table is equipped with an Overhead Lighting and Scoring unit, install the unit at this time using the instructions included with the unit.

If your table is not equipped with an Overhead, it should come with a side-mount scoring unit.

Taped to the bottom of the cash box are two #106 keys, which are used to open the access door (located on the same side of the table as the coin housing assembly). Open the access door and locate the power cord which is coiled and lying on the floor of the access area. Locate the hole in the floor and feed the cord through this hole. Near the coin door is a label indicating the operating voltage of your table. Note also that your outlet must have a working ground. Do not attempt to bypass the grounding feature of your outlet. Plug the table in after verifying that the voltage is correct.

Located on the floor of the access area is a toggle switch labeled "on" and "off." You will now need to toggle this switch into the "on" position. At this point the side-mount display unit will illuminate.



Side-Shield Installation

Dynamo's 3-piece Shield set will help to keep the puck on the table and discourage the placement of drinks on the table's side rails. While it will create a safer environment, no shield has been invented that will keep every puck on every playfield every time. Exercise caution during play, keep hands and fingers clear of the playfield, and follow the instructions from Dynamo Caution Label, part # 850404030

Kit Contents:

- Side Shields 2
- Center Shield 1
- Rubber Grommets 18
- ¼-20 x 1" Black Oxide Hex Bolts 4
- Lock nuts 4
- ¼" Black Oxide Washers 8

Tool required

- Phillips Screwdriver

1. Remove the bolts from the Side Top Rail, except for the bolt at the very end of each Rail.
2. Insert Rubber Grommets into the holes from the top of each Side Shield
3. On the Fire Storm, align the Side Shield over the LED light strip, so the lighting is inside the groove of Side Shield.
4. Mount with the flange of the Shields to the outside.
5. Re-install the Top Rail bolts previously removed
6. Install (2) Rubber Grommets in each of the Side Shields, from the outside
7. Install the Center Shield by aligning it with the two holes in each Side Shield and assemble using (4) each of the bolts and nuts, as well as (8) Washers.

CAUTION-TO PREVENT PUCK FROM FLYING OFF TABLE AND CAUSING POSSIBLE INJURY, BE SURE THE PUCK IS LAYING FLAT ON THE TABLE SURFACE BEFORE STRIKING WITH Mallet AND USE ONLY DYNAMO MANUFACTURED PARTS.





Rules of Play

SCORING

- The first player to score 7 points wins the game.
- A point is scored when the puck enters **and falls into** the goal.
- After a point is scored, the player scored upon receives possession of the puck for the next serve.

CENTERLINE

- If any part of the puck is on the centerline, either player may hit it. If the puck is completely within one player's half of the table, not touching the centerline, the opposing player may **not** hit it. Violation of this rule constitutes a **foul** (forfeiture of possession of the puck).
- It is a foul if a player's mallet **completely** crosses over the centerline.

PUCK OFF THE TABLE

- When a player offensively strikes the puck and causes it to leave the playing surface, that player is guilty of a **foul**.
- If, however, the puck leaves the table while a defensive player is **blocking** a shot, by moving his mallet sideways, backwards, or not at all, the **offensive** player is guilty of a foul and the defensive player gets a possession of the puck.
- If the defensive player charges **forward** to block a shot, and the puck leaves the table, the defensive player commits a foul and loses possession of the puck.

LOSS OF MALLETT

- It is a foul for a player to lose total control of his mallet.
- It is a foul for a player to "top" the puck by lifting his mallet and placing it on top of the puck.
- It is a foul when a player's hand, body or clothing touches the puck while the puck is on the table and in play.

GOAL TENDING

- If a player's hand, body or clothing touches the puck while the puck is moving in a direct path toward that player's goal, "goaltending" must be called. Goaltending constitutes a **technical foul**, which allows the opponent a **free shot** at the penalized player's unprotected goal.

7 SECOND RULE

- A player has 7 seconds to execute a shot, which crosses the centerline.
- The 7 seconds begins as soon as the puck enters and remains on that player's side of the centerline. Violation of this rule is a foul.

FOULS

- If a player commits a foul and is scored upon in the course of the same play, the goal counts and the penalty is nullified.
- If a foul occurs and the innocent player immediately gains possession of the puck anyway, the referee should simply allow play to continue and not interrupt the game.

MALLETS AND PUCKS

- Mallets and pucks must meet standards and requirements of the U.S. Air-Table Hockey Association.

TOURNAMENT PLAY

- Tournament play shall begin with a coin toss. The winner has the option of the first serve or choosing which end of the table he prefers. Players then alternate first serves **and** table sides for each subsequent game of that match.

REFEREE

- A referee should judge each game in tournament play.

FACE-OFF

- A face-off should be used in a case where the referee is unable to determine which player committed the foul. The puck is placed flat at the center of the table, with the player's mallets allowed no closer than 1/2 inch from the puck. When the referee releases the puck, both players may hit it.

PENALTIES

- A player committing a **Foul** is penalized by loss of possession of the puck.
- A **Technical Foul** allows the penalized player's opponent one **free shot** at the player's unprotected goal. If the free shot misses, the puck is immediately in play.



Routine Maintenance

Follow these suggestions to insure your table's maximum earning power and player appeal over the years to come.

PUCKS AND MALLETS: Special pucks and mallets are made for Dynamo Hockey. The pucks and mallets you receive with your table are superior to any others available. It is extremely important to use the highest quality pucks and mallets if your table is to play properly and achieve maximum earnings.

It is important to avoid the cheaper, imported pucks, which are slower, lighter, chip more easily, and tend to fly off the table, resulting in loss of play time, player dissatisfaction, and loss of earning. Because of their inherent instability (i.e.: flying off of the table), there is a risk of player injury when the cheaper pucks are used.

Fluorescent puck: The Dynamo Fluorescent puck (860400090) is made of glass-filled Lexan and was developed specifically for the Dynamo Hockey table. This deluxe puck had been designed and tested for superior speed, visibility, durability and stability on the table. The fluorescent Lexan puck is the best puck on the market and we highly recommend its use to insure a high level of earnings and player appeal.

White quiet puck: Also available is our white quiet puck (860400150) made from a softer, noise-reducing material. The quiet puck is recommended in situations where noise reduction is a necessity.

Fluorescent mallets: Our deluxe mallets (860400210) were designed to give the puck the maximum rebound yet absorb the impact and keep it away from the player's hands. This took years of testing and balancing of the chemical formula to get it right. It seems unimportant, but the sooner a player's hands are hurting the sooner they stop playing. This mallet will also outlast the lightweight imports many times over. Be sure to look for the Dynamo logo on your mallets.

The Dynamo approved pucks and mallets are available from a number of parts distributors as well as www.valleydynamoparts.com. Be sure to specify the Dynamo Deluxe pucks and mallets. We have added our logo to help identify them for you.

SANDPAPER: A piece of adhesive-backed 240-grit sandpaper (980400200) has been included with your table. This should be attached to the side or end of the table, or nearby, so players can sand the puck when it stops floating properly due to small nicks and abrasions. Do not attach the sandpaper to the back of the metal goal end where it could damage clothing. Sandpaper discs (980400200) can be obtained from www.valleydynamoparts.com, Dynamo distributors, a hardware store, or from one of the parts companies supplying this industry. Sandpaper, like pucks and mallets, should be replaced when showing excessive wear.

CLEANING: Excessive dust on the surface of your table will slow the puck significantly. To prevent this, the table should be cleaned once a week -- more often if necessary. We highly recommend rubbing alcohol (isopropyl alcohol) to clean the plastic laminate surface. Liquid window cleaners are also acceptable. Always clean the plastic laminate surface with the air on to ensure that the cleaning process does not force the dirt down into the air holes. Use a small amount of the cleaning solution on a clean paper towel to clean off the dust and dirt. Regular cleaning and maintenance of the playing surface can prevent the holes from becoming plugged.

Once a year or so, check the condition of the air holes. If any debris has been forced down into the air holes, it can be removed with the following method: With the air ON, use a Dremel Moto-tool or equivalent, with a 1/32" drill bit. Slowly insert the rotating drill bit into the hole. This will cause the debris to "ride" up the grooves on the drill bit and out onto the playing surface. Do not use a pushpin to simply push the debris down into your table.

When cleaning the table surface, do not clean off the side rails where the puck hits. The thin layer of dirt helps the puck bank properly and keeps it on the table.

***NEVER USE SILICONES, WAXES, OR ANY OTHER PRODUCT THAT
COULD LEAVE A RESIDUE ON THE PLAYING SURFACE.
THE USE OF THESE PRODUCTS WILL CAUSE A BUILDUP
OF DEBRIS IN THE AIR HOLES.***

LIQUIDS: There should be no drinks placed on the table. Ever. Any liquid spilled on the surface must be wiped up immediately. Large amounts of any liquid can seep down the holes and into the wood, which will warp the playing surface. We recommend prohibiting drinks from being placed on the table at any time. Side shields are effective in discouraging customers from putting drinks on the table.



Operation and Programming

The following applies to all Dynamo Hockey games, regardless of logic board type.

POWER UP:

Onboard diagnostics begin as soon as your Dynamo Hockey table has been powered up. These diagnostics verify the correct functioning of the processor internal RAM and determines that the onboard timer/counter is functioning correctly. At this point, your display will show an "8" on the left segment of the score display.

If the board diagnostics pass, both I/O ports (coin switch and score optics) are then checked. Upon successful completion of this process, an "8" on the right segment of the score unit will flash once.

**If the "8" lights and stays lit, the diagnostics did not pass.
In this event, refer to the Troubleshooting chapter of this manual.**

ATTRACT MODE:

The A/C blower motor and goal solenoids are turned off.

The last game's score (if any) and the current number of pending credits (if any) are shown on the score display, as follows:

The last score (if any) is displayed for three seconds.

The letter "c" (for credits) is flashed briefly once.

The number of credits (if any) is displayed for three seconds.

If there are no pending credits, this cycle will repeat until a coin drop is detected.

If there is a pending credit in place, the game will automatically start after cycling through the attract mode once.

GAME PLAY MODE:

The A/C blower motor and the puck drop solenoids are activated for the duration of the game. The timer countdown is started, and the score display is reset to "0."

Each puck drop detected is a score awarded to the appropriate player. When either player reaches a score of 7, or the timer reaches its preset value, the game is over and the system returns to Attract Mode.

Any coin drops are accepted at any time, including during the Game Play Mode.

ADJUSTABLE TIMER:

Your Dynamo Hockey table is equipped with a length-of-game timer, which may be adjusted between one to sixteen minutes. The default setting for this timer is seven minutes. Since the average game ends within three to four minutes, this setting is usually adequate, but the timer may be adjusted to meet your requirements. Refer to the Program Configuration pages (17-19) for the timer adjustment parameters.

COIN COUNTER:

Your Dynamo Hockey is equipped with a coin counter. This counter is advanced once for every credit detected.

Dynamo Hockey
V7.01 Program Configuration
U.S. 110v tables

To change the default values

- Hold down the ACCESS button, the scoring display will count down from five and display the letters PE (Parameter Entry)
- Release the ACCESS button after the countdown and the menu system has been accessed
- Change values for each setting using the “VALUE” button. Press the “ACCESS” button to move to the next configurable setting.
- When all configurable values have been set, the program exits the setup routine and the values have been stored.

· **SC** **Maximum score (for a player) per game**

- Default Value 7
- Minimum Value 2
- Maximum Value 9

· **LE** **Maximum time in minutes a game will run**

- Default Value 7 minutes
- Minimum Value 0 (score setting determines game length)
- Maximum Value 16 minutes

· **CC** **Coins per credit**

- Default Value 1
- Minimum Value 1
- Maximum Value 8

· **PC** **Plays per credit**

- Default Value 1
- Minimum Value 1
- Maximum Value 3

To Set Software Defaults

User should hold down the VALUE button in the PC Board when powering up the game. The LED display flashes “FP” (Factory Parameters) when the system defaults have been set. After “FP” has flashed, the display continues into startup mode. At this point you are done setting the defaults.

Dynamo Hockey
V9.0 Program Configuration
U.S. 110v Tables with sound

Setting Software Defaults

- To set the table to Factory Defaults, hold down the 'VALUE' button on the PC Board while powering up the table. After the usual startup check display of '88', the LED display flashes 'FP' (Factory Program). Releasing the 'VALUE' button starts the program using Factory Default values.
- To change the Default Values of the game, the user should hold down the 'ACCESS' button while the table is ON. A countdown from 5 to 1 begins on the LED display, followed by 'PE' (Program Edit). Release of the 'ACCESS' button before 'PE' is displayed will restart the game and not access the edit mode. Release of the ACCESS button when 'PE' is shown will display the TITLE of the first configurable setting for one second, followed by its value. The value may be changed by, not surprisingly, pressing the 'VALUE' button. The value increases with each push of the 'VALUE' button up to the maximum shown in the table below, and then returns to the minimum value. Pressing 'ACCESS' again will display the next value to view or change. At the end '- -' will be displayed.

· **SC** **Maximum score (for a player) per game**

- Default Value 7
- Minimum Value 2
- Maximum Value 9

· **LE** **Maximum time in minutes a game will run**

- Default Value 7 minutes
- Minimum Value 0 (score setting determines game length)
- Maximum Value 16 minutes

· **CC** **Coins per credit**

- Default Value 1
- Minimum Value 1
- Maximum Value 8

· **PC** **Plays per credit**

- Default Value 1
- Minimum Value 1
- Maximum Value 3

· **SO** **Sound on and off**

- Default Value 1
- Minimum Value 0 (= off)
- Maximum Value 1 (= on)

HI **Number of rail hits per sound** (*Example: a setting of 3 allows a rail shot sound on every 3rd shot, a setting of 1 allows a sound on every rail shot. This keeps the table from making too much sound, if desired*)

- Default Value 1
- Minimum Value 0 (no strike sound)
- Maximum Value 5

· **At** **Attract Sound Spacing (in minutes)**

- Default Value 1
- Minimum Value 0 (no attract sound)
- Maximum Value 5

· **St** **Start Button (not found on coin operated games)**

- Default Value 0
- Maximum Value 1

· **tt** **For games with ticket printers only**

- Default Value 0
- Minimum Value 0 (tickets print at game end)
- Maximum Value 1 (tickets print when goal scored)

- User can control the Background sounds (crowd sounds and demo music) using the Background volume control
- User can control the Effects sounds (rail shots, coin drop sounds, scoring, etc) using the Effects volume control
- User can control the Rail Shot sensitivity using the VR1 potentiometer on the board.

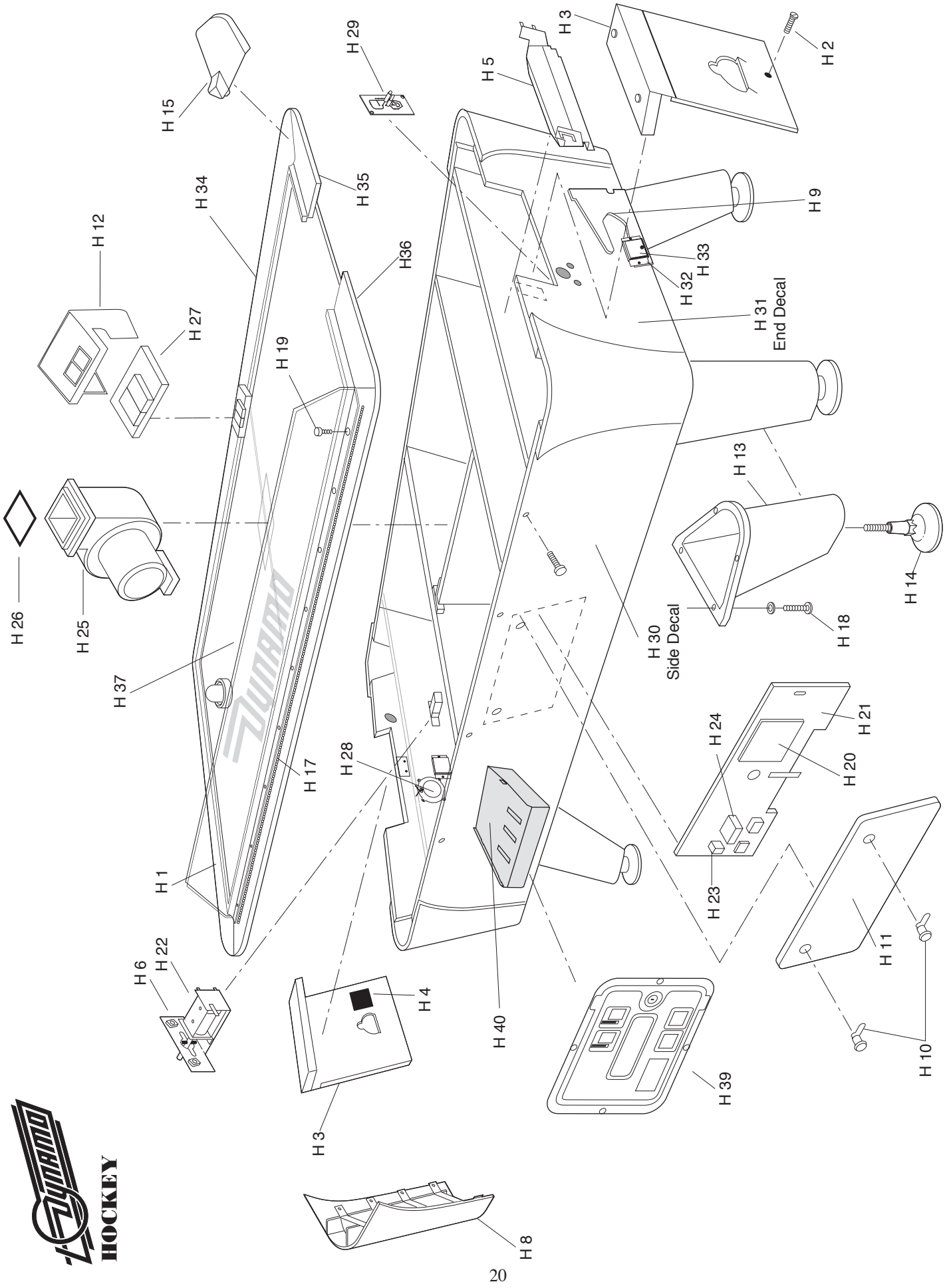



Exploded Parts Diagram

Identifiers on the drawing correspond to the part numbers listed below.
Order the correct part number for your table.

Remember : there's no such thing as an "H3". *The Part number is key.*

Ref #	Part Number	Item Description
*	860400090	PUCK, FLUORESCENT
*	860400150	PUCK, FLUORESCENT QUIET WHITE
*	860400210	MALLET, FLUORESCENT WHITE
*	980400200	SANDPAPER DISC
H1	030400260	3-PIECE SHIELD SET
H1	030400300	3-PIECE SHIELD SET FOR SHORT SHOT
H2	980000705	LOCK WITH 1KEY #J8045 SCREW LOCK GOAL ENDS
H2	030000140	KEY J8045 GOAL ENDS
H3	800401921	GOAL END, LOCK ENTRY, BLACK, BEST SHOT / PROSTYLE
H3	800401991	GOAL END, LOCK ENTRY, FLUORESCENT, HOT FLASH II
H3	800400961	GOAL END, LOCK ENTRY W/SPEAKER GRILLE, BLUE, SHORT SHOT
H3	800450010	GOAL END, LOCK ENTRY W/SPEAKER GRILLE, ORANGE, FIRE STORM
H3	800400951	GOAL END, LOCK ENTRY, SILVER, BLUE STREAK
H4	850400470	OPTO-SHIELD DECAL FOR GOAL END
H5	800401800	GOAL ENTRY
H6	800402300	BRCKT,SOLENOID
H6	800402310	BRCKT,DC SOLENOID
H8	860000300	CORNER, DOWN, BLACK
H9	960402805	DROP, PUCK
H10	980000530	LOCK WITH #106 KEY FOR SERVICE DOORS
H10	030000130	KEY #106 - SERVICE DOORS
H11	990400602	SERVICE ACCESS DOOR - BLANK
H12	030402015	KIT, SIDE MOUNT SCORING DISPLAY
H12	800401910	BRKT, SCORE SIDE MOUNT, BLACK
*	860400300	LENS, RED SIDE MOUNT SCORE DISPLAY
*	730408400	WIRE HARNESS, SCORE, SIDE MOUNT EXTENSION
H13	860001325	LEG, BLACK
H14	20607560	LEG LEVELER
H15	860400030	CORNER, PLASTIC COVER HOCKEY (ONLY ON TABLES WITHOUT ROUNDED RAILS)
H17	730450060	LED LIGHT STRIP FOR FIRE STORM
H17	730450065	LED LIGHT STRIP FOR SHORT SHOT
H18	N1020200030	LEG BOLT : 5/16-18 x 1 1/2 SLT HEX WWASHER
H19	N1870012309	BLACK RAIL/GOAL BOLT : MS, 1/4-20 X 1-1/2" PAN PHILLIPS

H19	NI870054205	THREADED INSERT : 1/4-20X.984 D142025 GOAL ANCHOR
H20	880400140	PCB, 9.0 DOMESTIC HOCKEY FOR TABLES WITH SOUND
H20	880400125	PCB, 7.0 DOMESTIC HOCKEY LOGIC USE WITH 880400715 10V TRANSFORM
H21	990401000	ASSY, SERVICE PANEL VER. 7.0 (BOARD AND ELECTRONICS)
*	730400100	WIRE HARNESS, MAIN HOCKEY
*	730400200	WIRE HARNESS, EXPORT CE HOCKEY
*	730408305	WIRE HARNESS, SCORE DISPLAY MAIN
H22	880400300	SOLENOID,120 AC - USA DOMESTIC
H22	880400320	SOLENOID,12 DC CE TABLES ONLY
*	879900150	SOLENOID LOCKING PIN, 1/8 x 3/4 ROLL PIN
*	980400100	SOLENOID RETURN SPRING
H23	880400600	RELAY,G4W-11123A USTV8HP12DC
H24	880400715	TRANSFORMER, 120V TO 10 VAC - USE WHEN UPGRADING pre-2004
H24	880400720	TRANSFORMER ,STEP DOWN 220V TO 110V AC
H25	880400900	BLOWER MOTOR 110V - USA DOMESTIC
H25	880400910	BLOWER MOTOR, 220V
H26	980400400	BLOWER MOTOR GASKET
H27	880400202	BOARD, LED SCORE SIDE MOUNT
H28	880300360	SPEAKER SET (OF 2) FOR TABLES WITH SOUND ONLY
H29	880404200	SCORE OPTIC BOARD
H30	860401458	DECAL,SIDE HOT FLASH II
H30	860450010	DECAL SIDE FIRE STORM
H30	860404160	DECAL,SIDE BLUE STREAK
H30	860402458	DECAL,SIDE BEST SHOT
H30	860404458	DECAL SIDE SHORT SHOT (SERVICE/COIN DOOR SIDE)
H30	860404459	DECAL SIDE SHORT SHOT (DOORLESS SIDE)
H31	860403458	DECAL,END HOT FLASH II
H31	860450000	DECAL END FIRE STORM
H31	860404150	DECAL,END BLUE STREAK
H31	860404000	DECAL,END BEST SHOT (PLAIN BLACK)
H32	800401000	GOAL END NUT BLOCK BRACKET
H33	960402810	GOAL END NUT BLOCK
H34	720400700	SIDE RAIL WITH ROUND CORNER, SILVER 7-FOOT (PRO-STYLE, BLUE STREAK)
H35	720400710	END RAIL WITH ROUND CORNER, RIGHT, SILVER 7-FOOT (PRO-STYLE, BLUE STREAK)
H36	720400720	END RAIL WITH ROUND CORNER, LEFT, SILVER 7-FOOT (PRO-STYLE, BLUE STREAK)
H34	720400800	SIDE RAIL WITH ROUND CORNER, SILVER 8-FOOT (BEST SHOT / PRO STYLE)
H35	720400810	END RAIL WITH ROUND CORNER, RIGHT, SILVER 8-FOOT (BEST SHOT / PRO STYLE)
H36	720400820	END RAIL WITH ROUND CORNER, LEFT, SILVER 8-FOOT (BEST SHOT / PRO STYLE)
H34	7204Y1306	SIDE RAIL WITH ROUND CORNER, FLUORESCENT HOT FLASH II
H35	7204Y2206	END RAIL WITH ROUND CORNER, RIGHT FLUORESCENT HOT FLASH II
H36	7204Y2406	END RAIL WITH ROUND CORNER, LEFT FLUORESCENT HOT FLASH II
H34	7204R1306	SIDE RAIL WITH ROUND CORNER, ORANGE FIRE STORM
H35	7204R2206	END RAIL WITH ROUND CORNER, RIGHT ORANGE FIRE STORM
H36	7204R2406	END RAIL WITH ROUND CORNER, LEFT ORANGE FIRE STORM
H37	020407031	PLAYFIELD, 8-FOOT BLUE W/SMALL LOGO (PRO-STYLE, BEST SHOT)
H37	020407181	PLAYFIELD, HOT FLASH II UV (BLUE W/LARGE LOGO)
H37	020407135	PLAYFIELD, FIRE STORM UV (BLACK W/FLAME TRIM)
H37	020407425	PLAYFIELD 7-FOOT BLUE W/SMALL LOGO (PRO-STYLE, BLUE STREAK)
H37	020407040	PLAYFIELD 5-FOOT BLUE W/SMALL LOGO (SHORT SHOT)
H39	880303140	COIN DOOR WITH LOCK, FRAME AND ROLL-DOWN MECHS
H40	800200750	METAL CASH BOX BOTTOM
H40	800200760	METAL CASH BOX LID
H40	860000815	PLASTIC CASH BOX FOR TABLES WITH 8-DEGREE DOOR

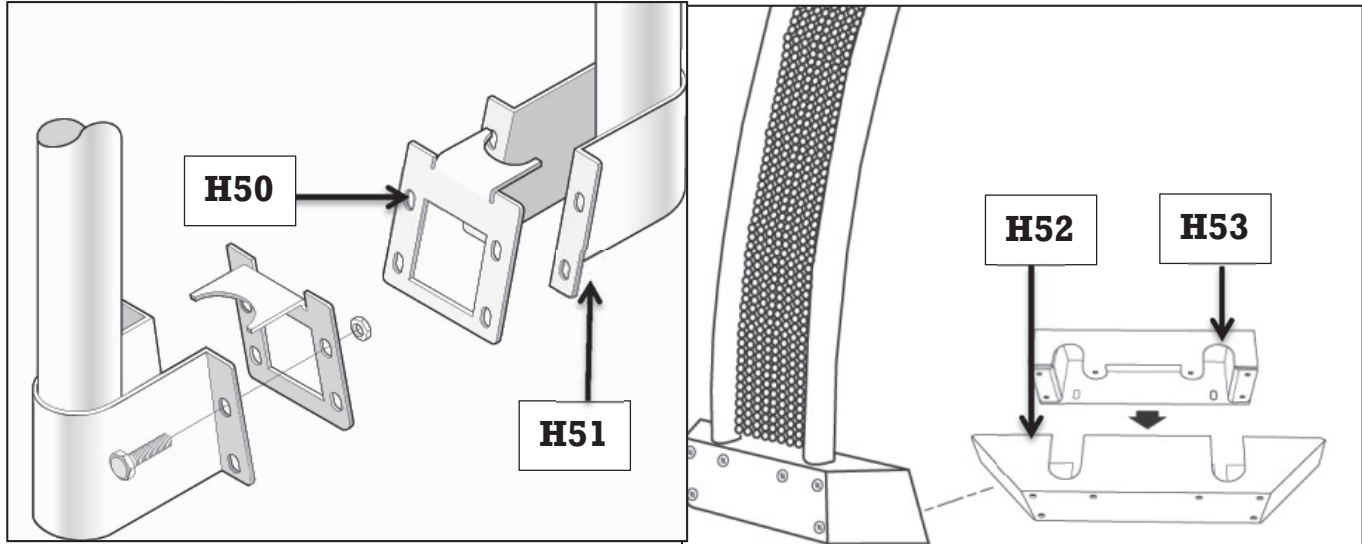

MOST OVERHEADS		
	880403101	SCORE DISPLAY BOARD OVER HEADS 2 PER OVERHEAD
H50	800404750	MOUNTING BRACKET CLAMP - HF II FLUORESCENT
H50	800404752	MOUNTING BRACKET CLAMP - SILVER
H50	800404762	MOUNTING BRACKET CLAMP - BLACK
H51	800404726	MOUNTING BRACKET (SIDE) - HF II FLUORESCENT
H51	800404728	MOUNTING BRACKET (SIDE) - SILVER
H51	800404738	MOUNTING BRACKET (SIDE) - BLACK
	870048150	WASHER ¼" ZINC
	870012307	SCREW, BLACK, PAN HEAD PHILLIPS ¼-20 x 1"

FIRE STORM OVERHEAD ONLY		
H52	800450110	OVERHEAD TUBE COVER - FIRE STORM
H53	800450090	MOUNTING BRACKET CLAMP - FIRE STORM

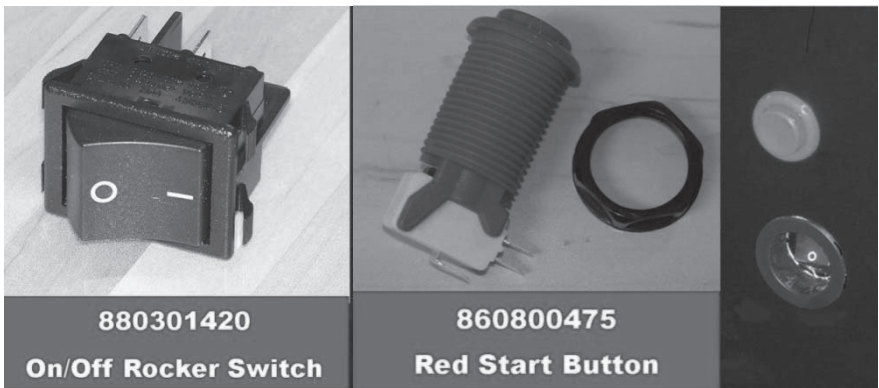

880301420
On/Off Rocker Switch

860800475
Red Start Button

← **For Non-coin
home-model
tables only**



PCB Identification

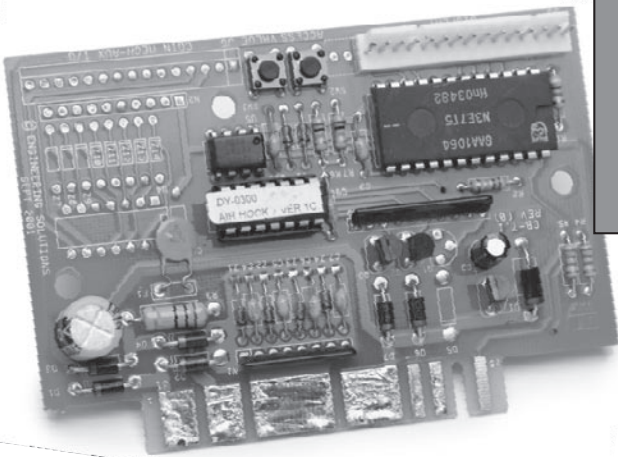

**V7.0 – U.S. 110v tables
Without sound
part # 880400125**

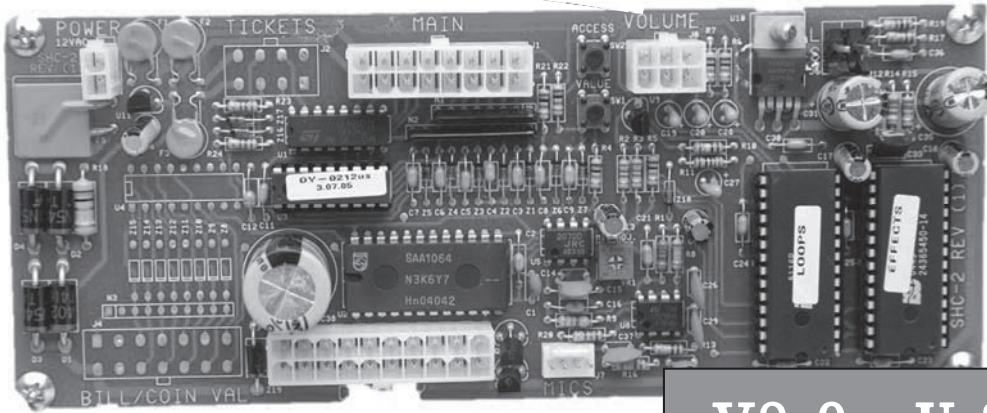

**V9.0 – U.S. 110v tables
With sound
part # 880400140**

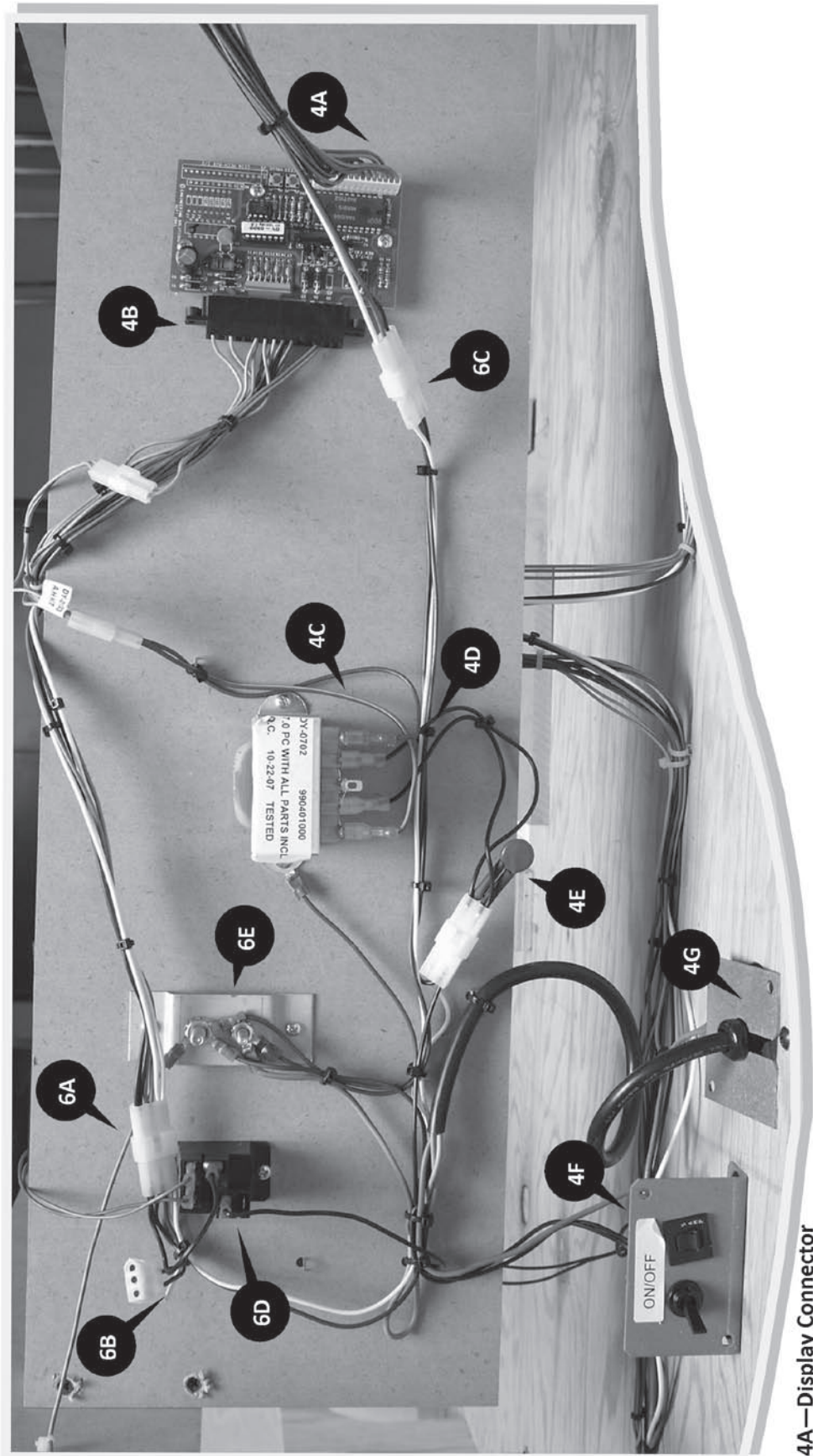

- 4A—Display Connector
- 4B—12v 30-pin Connector
- 4C—Transformer Output
- 4D—Transformer Input
- 4E—Transformer supply line w/Varistor
- 4F—5-amp Breaker
- 4G—Power Cord

- 6A—Blower Motor Connector
- 6B—Solenoid Connector
- 6C—Blower Motor—Constant 120v Test Point
- 6D—Relay
- 6E—Ground Bracket

**V7.0 – U.S. 110v tables
Without sound**

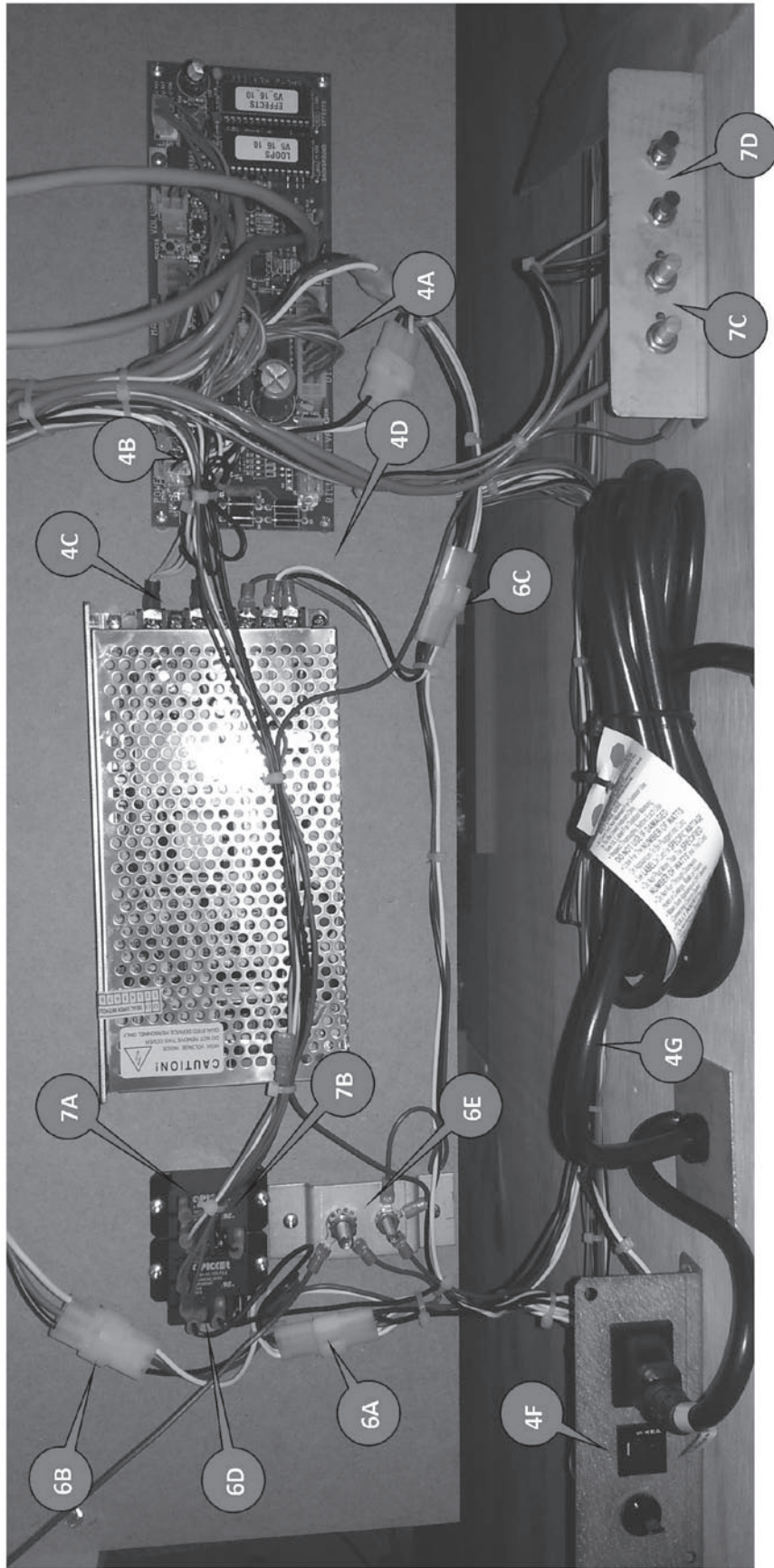

- 4A—Display Connector
- 4B—12v 2-pin Connector
- 4C—12v DC Output
- 4D—120v AC Input
- 4E—5-amp Breaker
- 4F—Power Cord

- 6A—Blower Motor Connector
- 6B—Solenoid Connector
- 6C—Blower Motor—Constant 120v Test Point
- 6D—Motor/Solenoid Relay
- 6E—Ground Bracket

- 7A—Light Relay Input
- 7B—Light Relay Output
- 7C—Volume Controls
- 7D—Programming Controls

**V9.0 – U.S. 110v tables
With sound**

Air Hockey Troubleshooting Flowchart

- These sheets are designed to help identify known common service issues with Dynamo Hockey tables, but are not a complete guide to everything that can possibly go wrong. It is our hope your table provides decades of reliable service and you never end up having to use them.
- If you are uncomfortable with these steps, or use of a voltmeter or ohmmeter, contact your distributor or a trained service professional to help diagnose and repair your table
- The current PCB versions are covered. For help with troubleshooting older Air Hockey tables with PCBs prior to the v7.01 model, visit www.valleydynamoparts.com.
- While repeatedly noted on the charts, it bears repeating once more : be absolutely sure your table is plugged into a known good 120v AC outlet.
- For several troubleshooting steps, we ask that you make sure you table is NOT plugged into this 120v outlet. Use caution. 120v AC is fine for Hockey tables, but can be very dangerous to people.
- Dynamo Tech Support : 972-595-5300 techhelp@valley-dynamo.com

CHART # 1, PROBLEM ISOLATION FLOWCHART

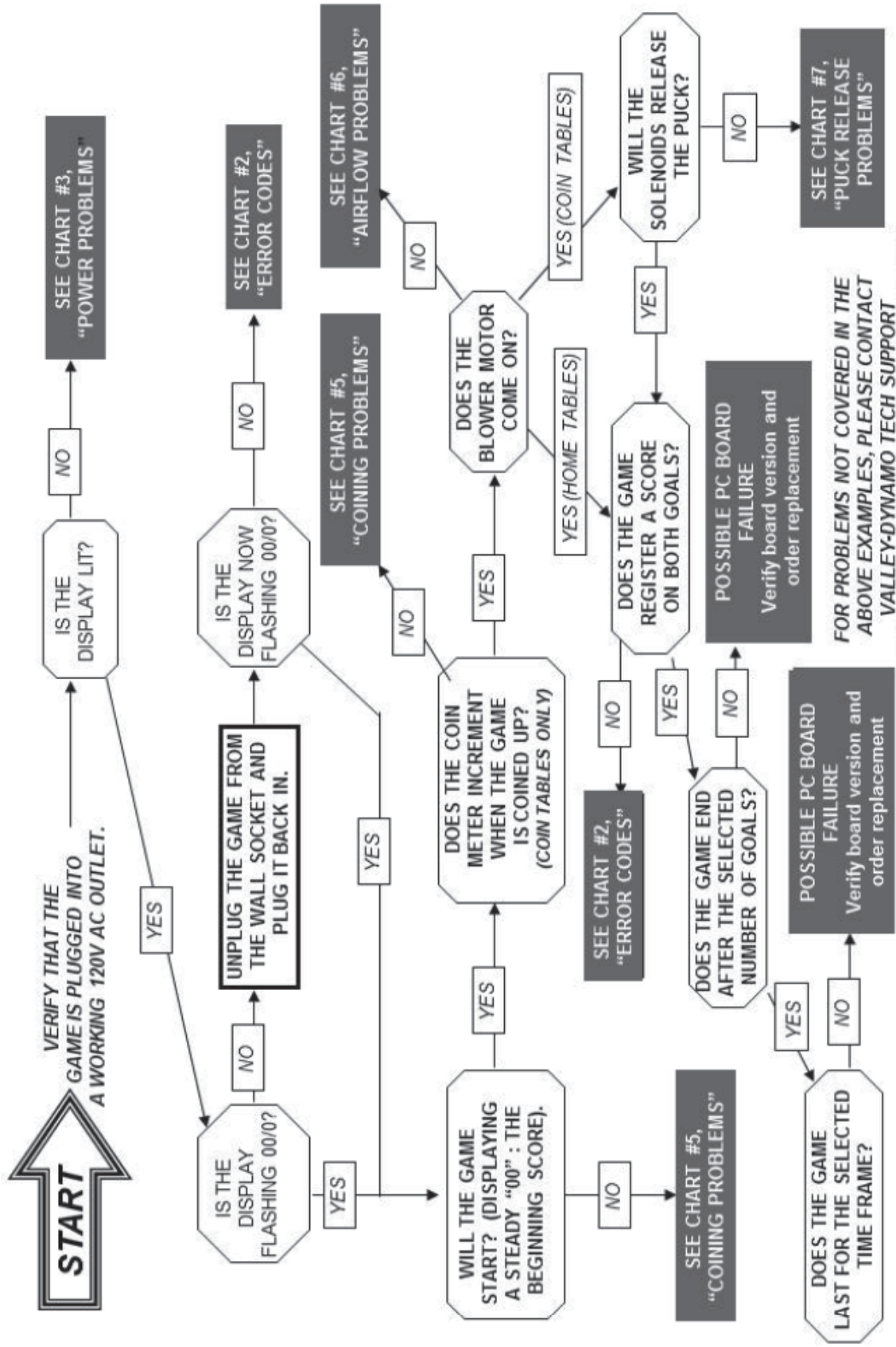

FOR PROBLEMS NOT COVERED IN THE ABOVE EXAMPLES, PLEASE CONTACT VALLEY-DYNAMO TECH SUPPORT 972-595-5300 TECHHELP@VALLEY-DYNAMO.COM

CHART # 2, ERROR CODES

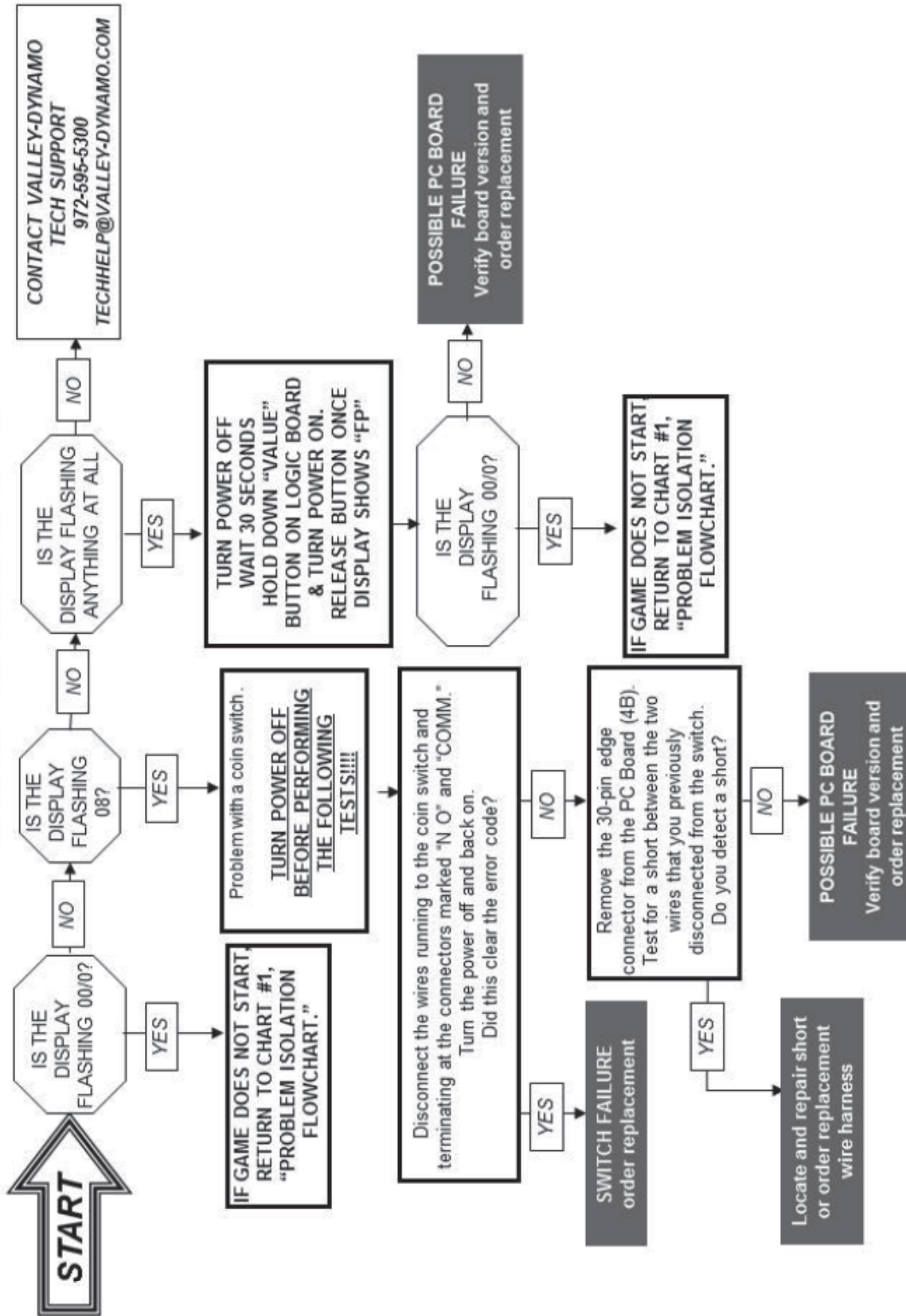
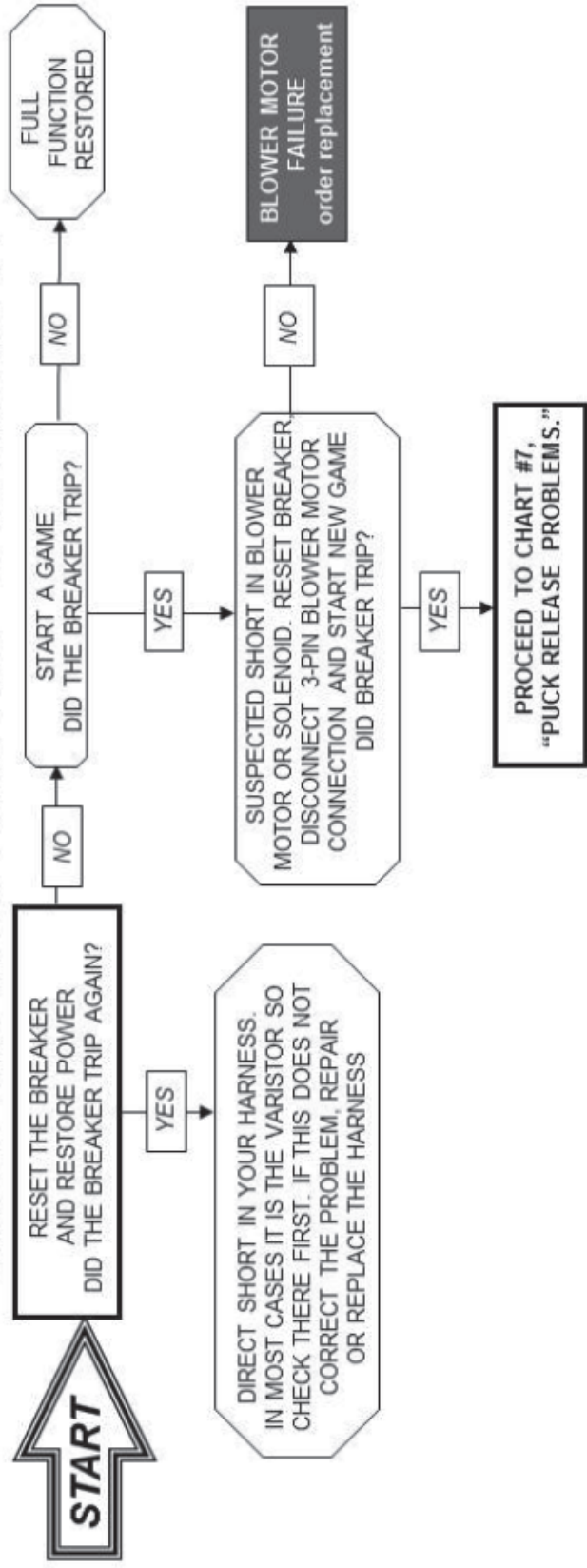
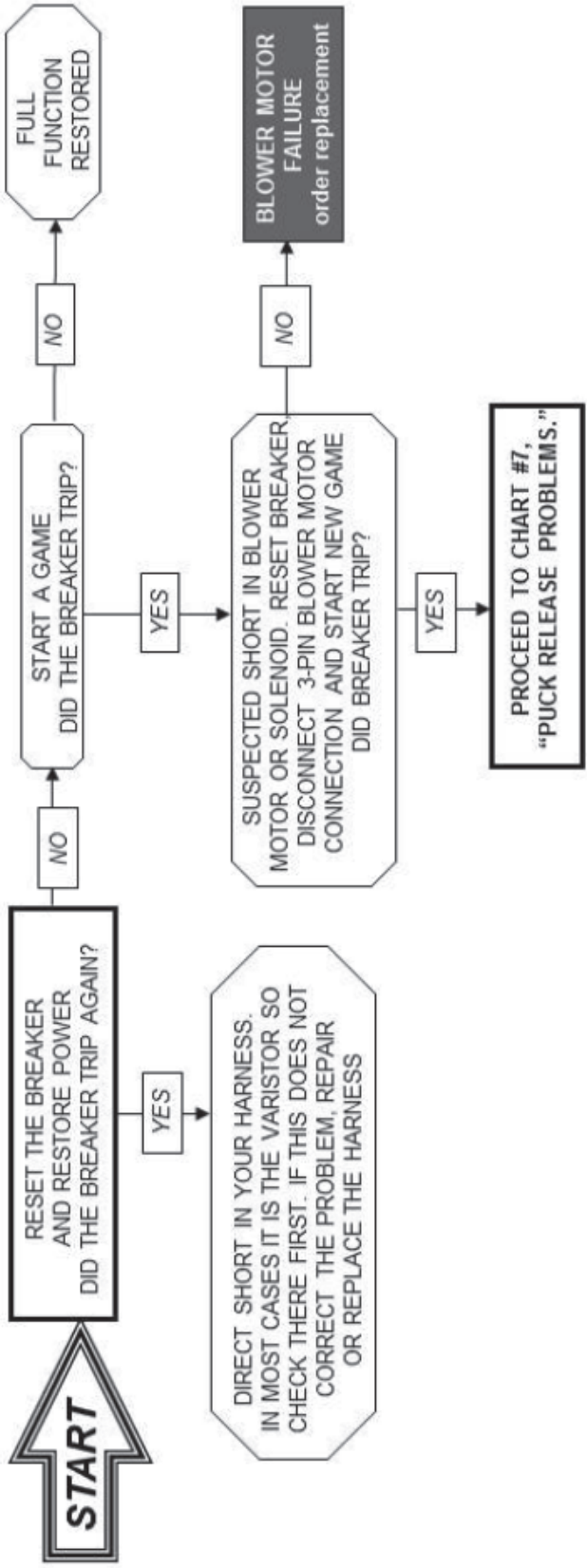

CHART # 3B, POWER PROBLEMS – VERSION 7.0 PCB



FOR PROBLEMS NOT COVERED IN THE
 ABOVE EXAMPLES, PLEASE CONTACT
 VALLEY-DYNAMO TECH SUPPORT
 972-595-5300 TECHHELP@VALLEY-DYNAMO.COM

CHART # 4, POWER PROBLEMS – VERSION 9.0 PCB



FOR PROBLEMS NOT COVERED IN THE ABOVE EXAMPLES, PLEASE CONTACT VALLEY-DYNAMO TECH SUPPORT 972-595-5300 TECHHELP@VALLEY-DYNAMO.COM

CHART # 5, COINING PROBLEMS

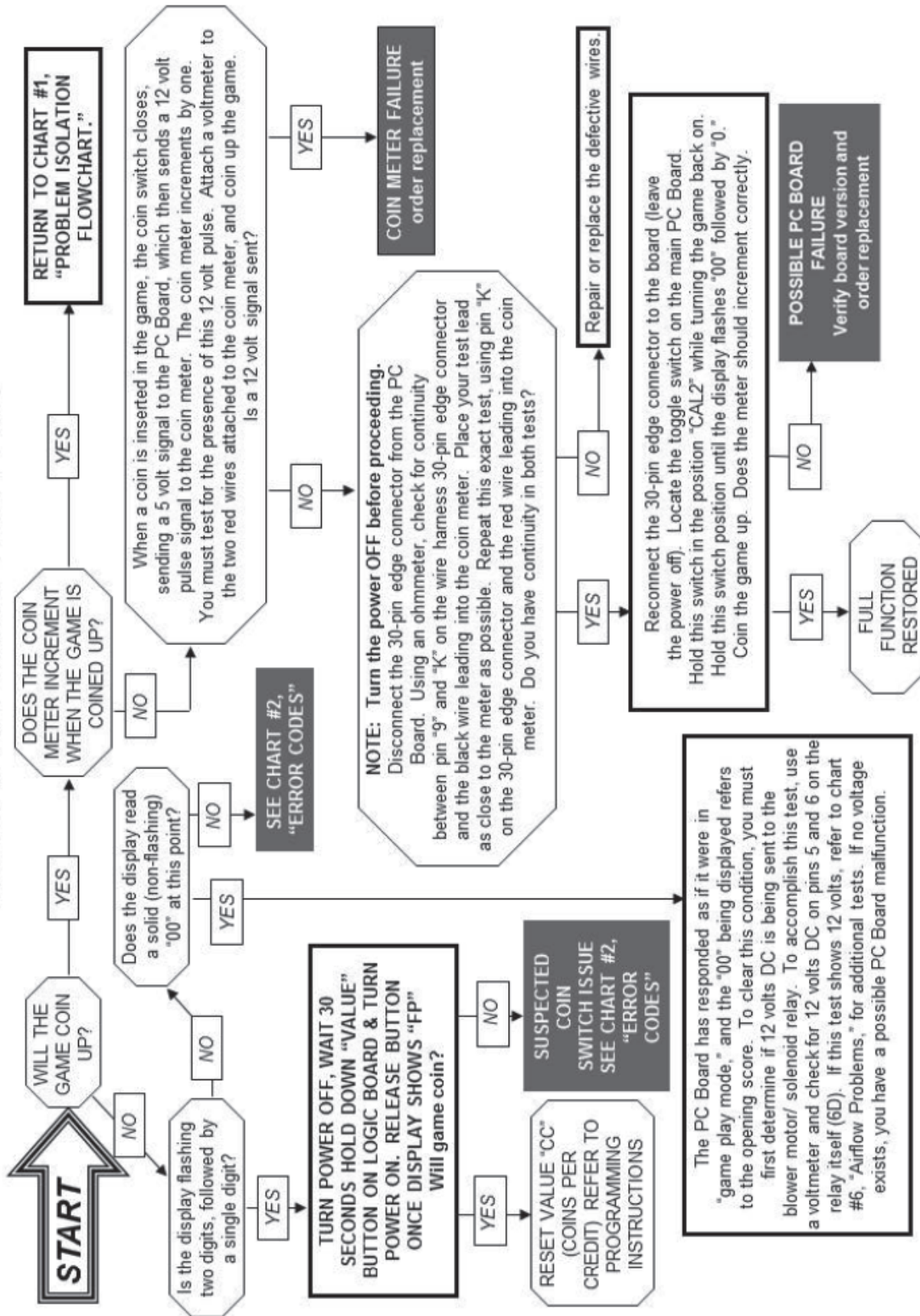

CHART # 6, AIRFLOW PROBLEMS (voltmeter and ohmmeter required)

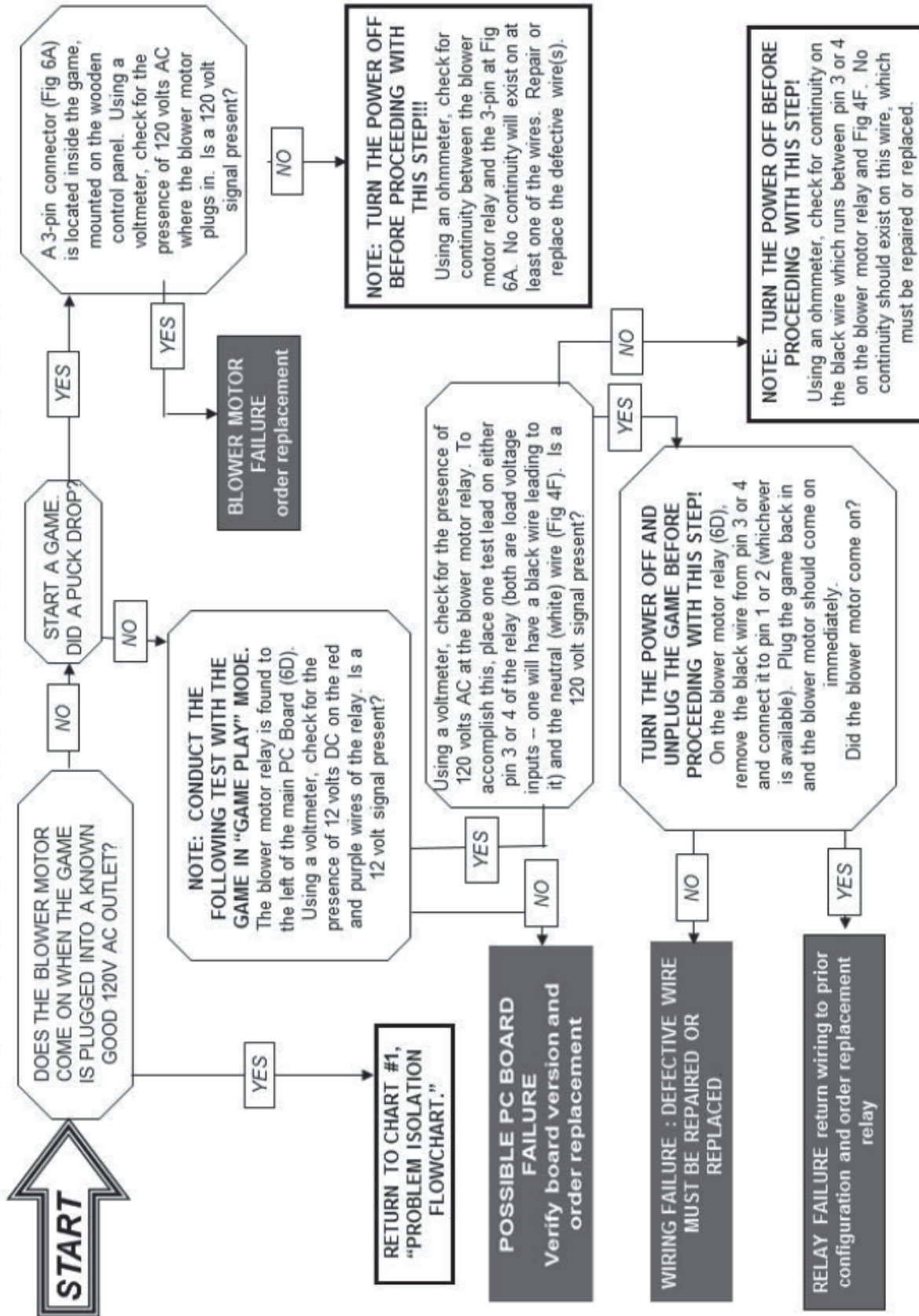
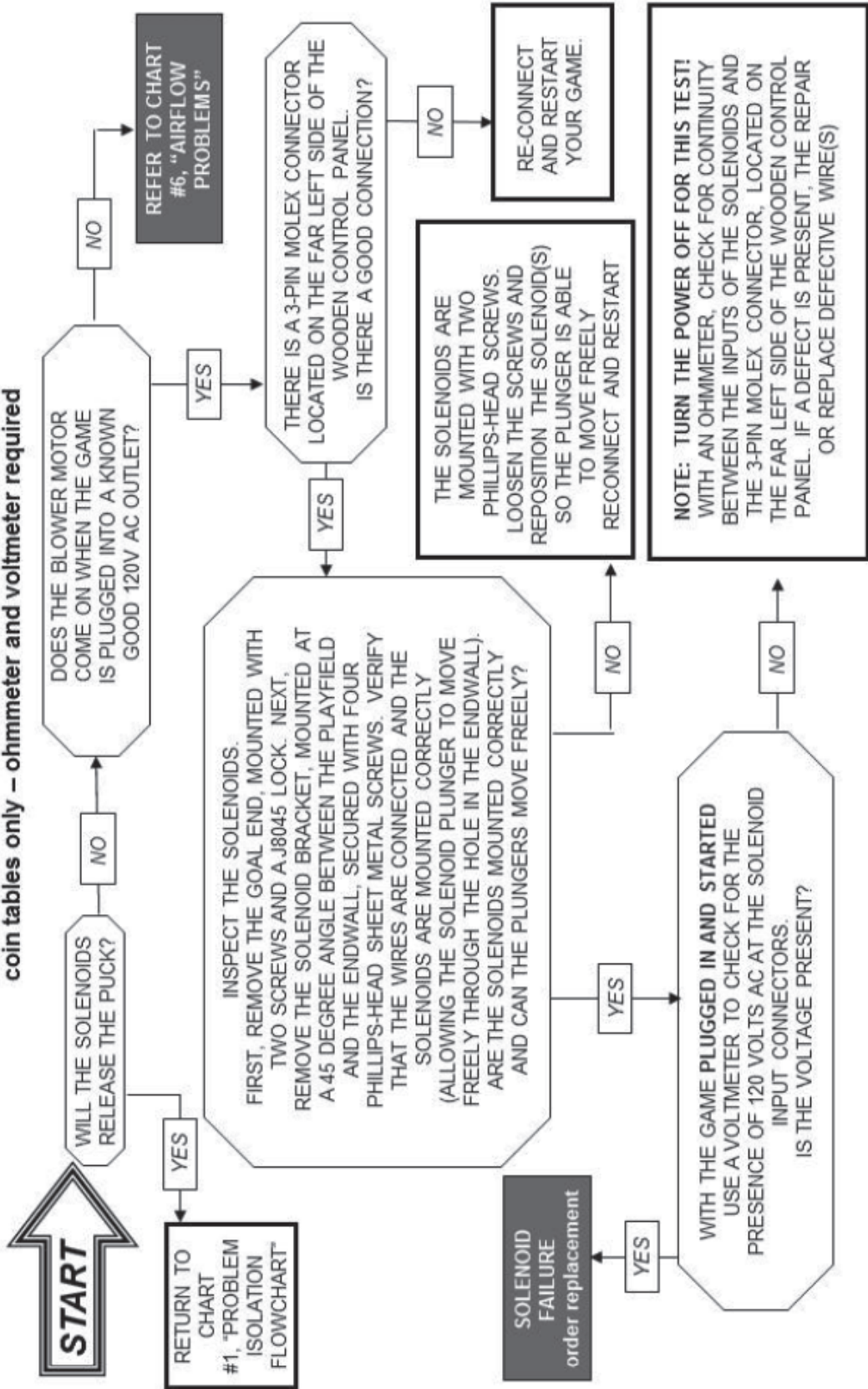
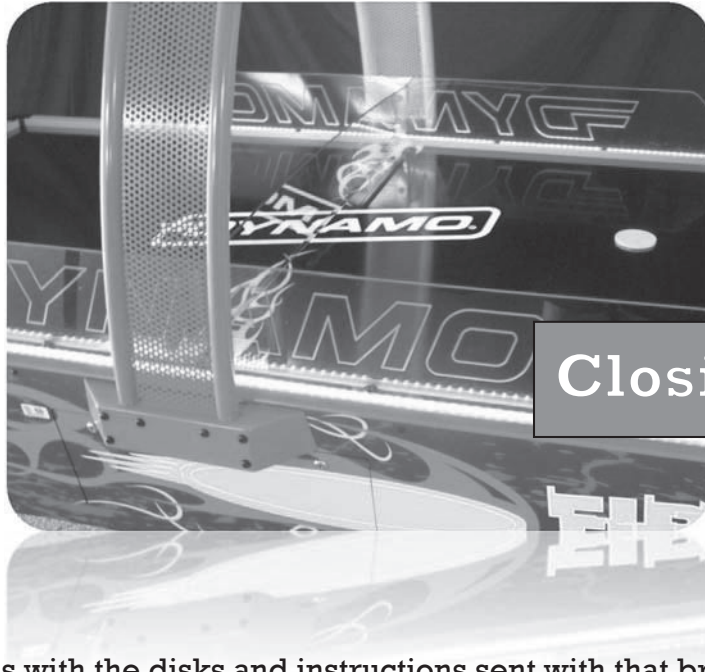

CHART # 7, PUCK RELEASE PROBLEMS

coin tables only – ohmmeter and voltmeter required



FOR PROBLEMS NOT COVERED IN THE ABOVE EXAMPLES, PLEASE CONTACT VALLEY-DYNAMO TECH SUPPORT 972-595-5300 TECHHELP@VALLEY-DYNAMO.COM



Closing Notes

Just as with the disks and instructions sent with that brand new Computer, Phone, Television, Printer, practically ANY electronic device these days, information can and will change between the time this was printed and the time you reached for the manual. Sometimes between printing and actual purchase.

The most current and complete troubleshooting, technical and parts breakdown information can be found at any time at

www.valleydynamoparts.com

For additional assistance:

Email anytime : techhelp@valley-dynamo.com

**During business hours (Central US Time) : call 972.595.5300
and follow the prompts for Tech support**

We hope your proudly American-built Dynamo Hockey table provides decades of trouble-free enjoyment. Thanks again for considering Dynamo.

