



Gold Fishin' Service Manual

Innovative Concepts In Entertainment, Inc.

Table of Contents

| | |
|--|----|
| Safety and Warnings | 3 |
| Game Assembly | |
| Assembly Check list | 4 |
| Fully disassembled Game setup instructions | 5 |
| Assembled Game setup instructions (Start on Step 15) | 11 |
| Mega Marquee | 13 |
| Changing Program Settings | 18 |
| Program Options | 19 |
| Suggested Settings for Ticket Payout | 20 |
| Audits | 21 |
| Removing the Ball Ramp | 22 |
| Fish Bowl Removal | 23 |
| Accessing Sensors | 24 |
| Sensor Layout | 25 |
| Serial Port Diagnostics | 26 |
| Rotary Diagnostics | 27 |
| Ball Dispenser Motor Replacement | 28 |
| Technical Information | 29 |
| Spare Part List | 33 |
| Warranty | 34 |

Rev D 5/19/2017

SAFETY AND WARNINGS BEFORE YOU BEGIN

WARNING: WHEN INSTALLING THIS GAME, A GROUNDED A.C. RECEPTACLE MUST BE USED. FAILURE TO DO SO COULD RESULT IN INJURY TO YOURSELF OR OTHERS. FAILURE TO USE A GROUNDED RECEPTACLE COULD ALSO CAUSE IMPROPER GAME OPERATION, OR DAMAGE TO THE ELECTRONICS.

NOTE: THIS GAME IS INTENDED FOR INDOOR USE ONLY.

DO NOT DEFEAT OR REMOVE THE GROUNDING PRONG ON THE POWER CORD FOR THE SAME REASON AS GIVEN ABOVE. USING AN IMPROPERLY GROUNDED GAME COULD VOID YOUR WARRANTY.

HAVE A QUALIFIED ELECTRICIAN CHECK YOUR A.C. RECEPTACLE TO BE SURE THE GROUND IS FUNCTIONING PROPERLY.

THIS GAME IS DESIGNED TO DISSIPATE STATIC ELECTRICITY THROUGH THE GROUNDING PLANE OF THE GAME. IF THE A.C. GROUND DOES NOT WORK, THE GAME COULD DISCHARGE STATIC ELECTRICITY THROUGH THE GAME CIRCUITRY, WHICH COULD CAUSE DAMAGE.

THE POWER SUPPLY IS NOT VOLTAGE ADJUSTABLE. TO OPERATE THE GAME AT VOLTAGES OTHER THAN THOSE IT WAS DESIGNED FOR. PLEASE CONTACT OUR SERVICE DEPARTMENT FOR VOLTAGE CONVERSION INFORMATION.

WARNING

DO NOT remove any of the components on the main board (e.g. compact flash and eproms) while the game is powered on. This may cause permanent damage to the parts and the main board. Removing any main board component part while powered on will void the warranty.

ALWAYS REMOVE POWER TO THE GAME, BEFORE ATTEMPTING ANY SERVICE, UNLESS NEEDED FOR SPECIFIC TESTING. FAILURE TO OBSERVE THIS PRECAUTION COULD RESULT IN SERIOUS INJURY TO YOURSELF OR OTHERS.

THIS GAME IS NOT SUITABLE FOR INSTALLATION IN AN AREA WHERE A WATER JET COULD BE USED.

This appliance is not intended for use by persons (including children) with reduced physical, sensory or mental capabilities, or lack of experience and knowledge, unless they have been given supervision or instruction concerning use of the appliance by a person responsible for their safety. Children should be supervised to ensure that they do not play with the appliance.

AC Power Information

The games main fuse is accessed through the back of the game at the power mod. Above the power cord is a small panel that contains the main fuse.

The value of the fuse for 120 volt users is 8 AMPS at 250Volt type slow blow.

The value of the fuse for 230 volt users is 4 AMPS at 250Volt type slow blow.

Your Game Should Include:

The game can be shipped assembled or disassembled. The hardware package included depends on how the game was shipped. Assembled games need only the marquee installed so you can skip to step 15. If you game included a Mega Marquee, please review the section “Gold Fishin Mega Marquee Instructions” for a list of additional components that should have be included.



OR



Fully disassembled games will have these items shown below in addition to the above items.

X's 2



///// FOUL LINE /////

Might be already mounted on Yellow bracket support.

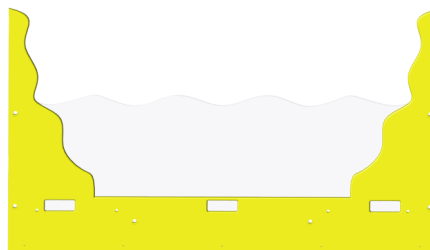

Might have rebound guard already mounted.

X's 2



X's 2

Shipped Fully Disassembled Instructions

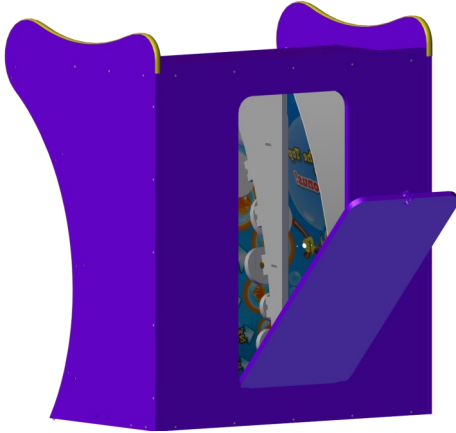

Step 1:

Open the back door of the upper cabinet and put aside.

Step 2:

Carefully lift the upper back section up onto the bottom cabinet.

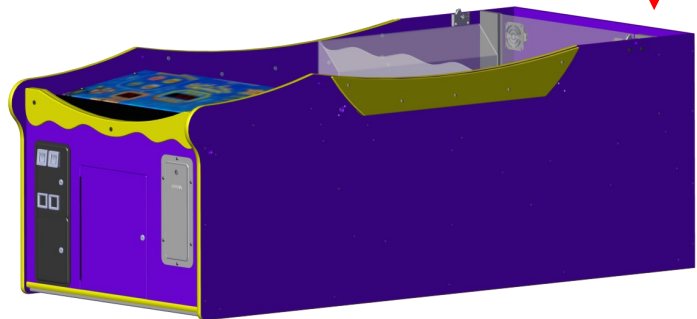

Step 3:

Lock the upper cabinet to the bottom cabinet using the provided latch tool. Connect the three harnesses shown and replace the back cabinet door.

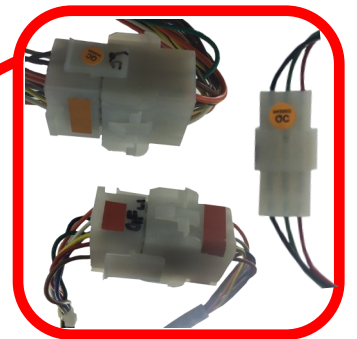
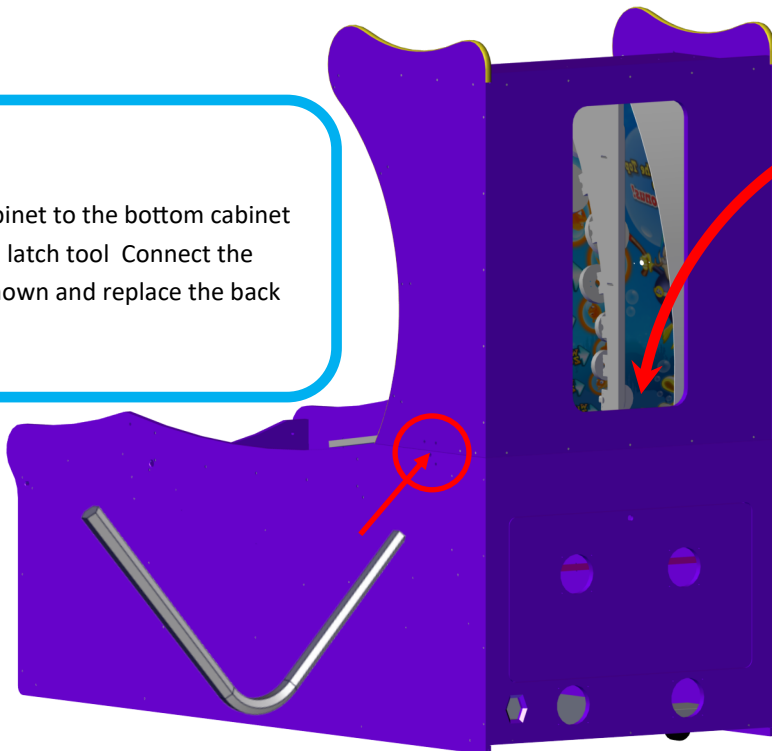

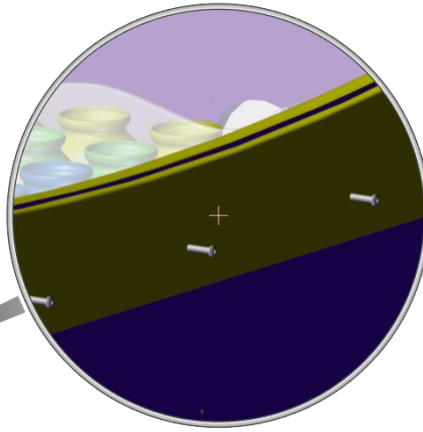

Step 4:

Loosen the bottom three bolts that hold the bottom bowl support.

Step 5: (DO NOT FULLY TIGHTEN BOLTS)

Locate the right bowls' front bowl support and loosen the outer bolts so that it can slide onto the fishbowl. The fishbowl should have its etching facing to the inside of the game when installed. Using 5 Zinc 1/4-20 x 1 (6048) bolts, attach the left support to the fish bowl. Do not fully tighten at this time.

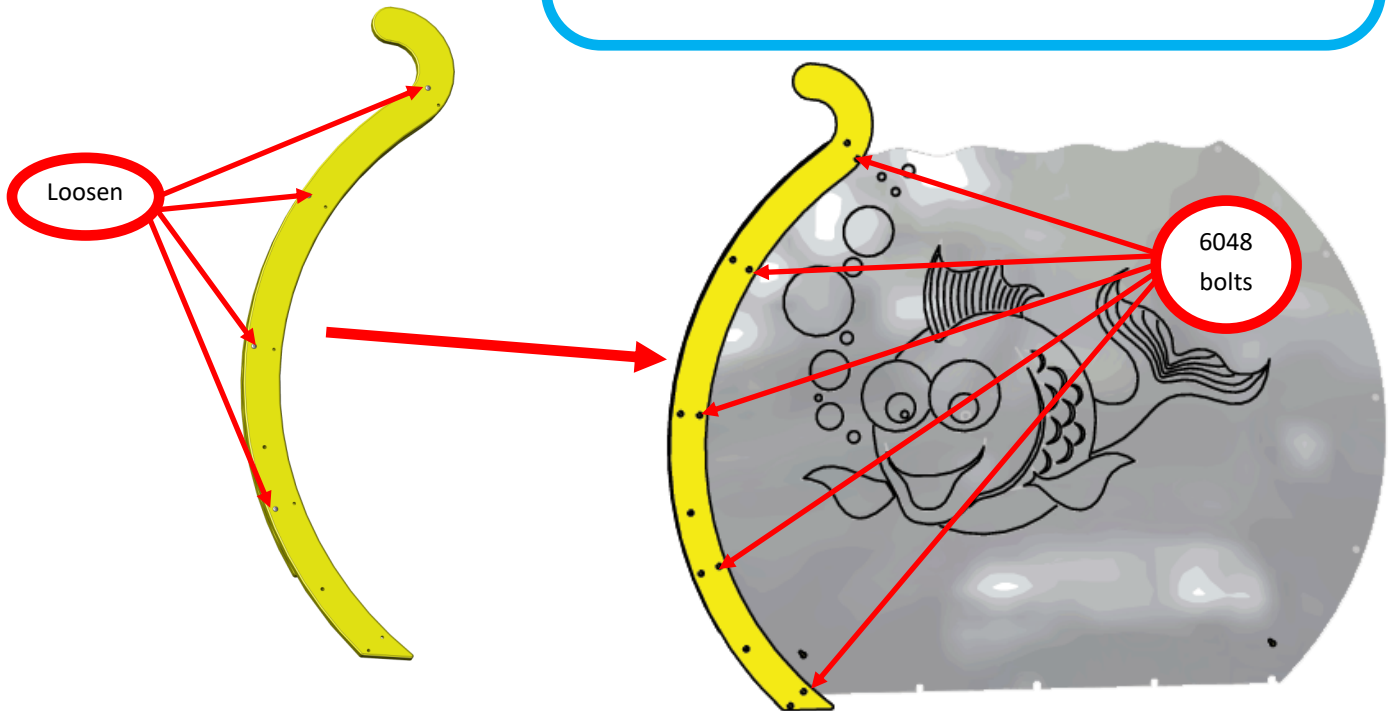

Step 6: (DO NOT FULLY TIGHTEN BOLTS)

Locate the right bowl and slide it into the bottom slot aligning the notches with the bolts. Attach the side bowl mount using 10 AA6102's. Do not fully tighten bolts.

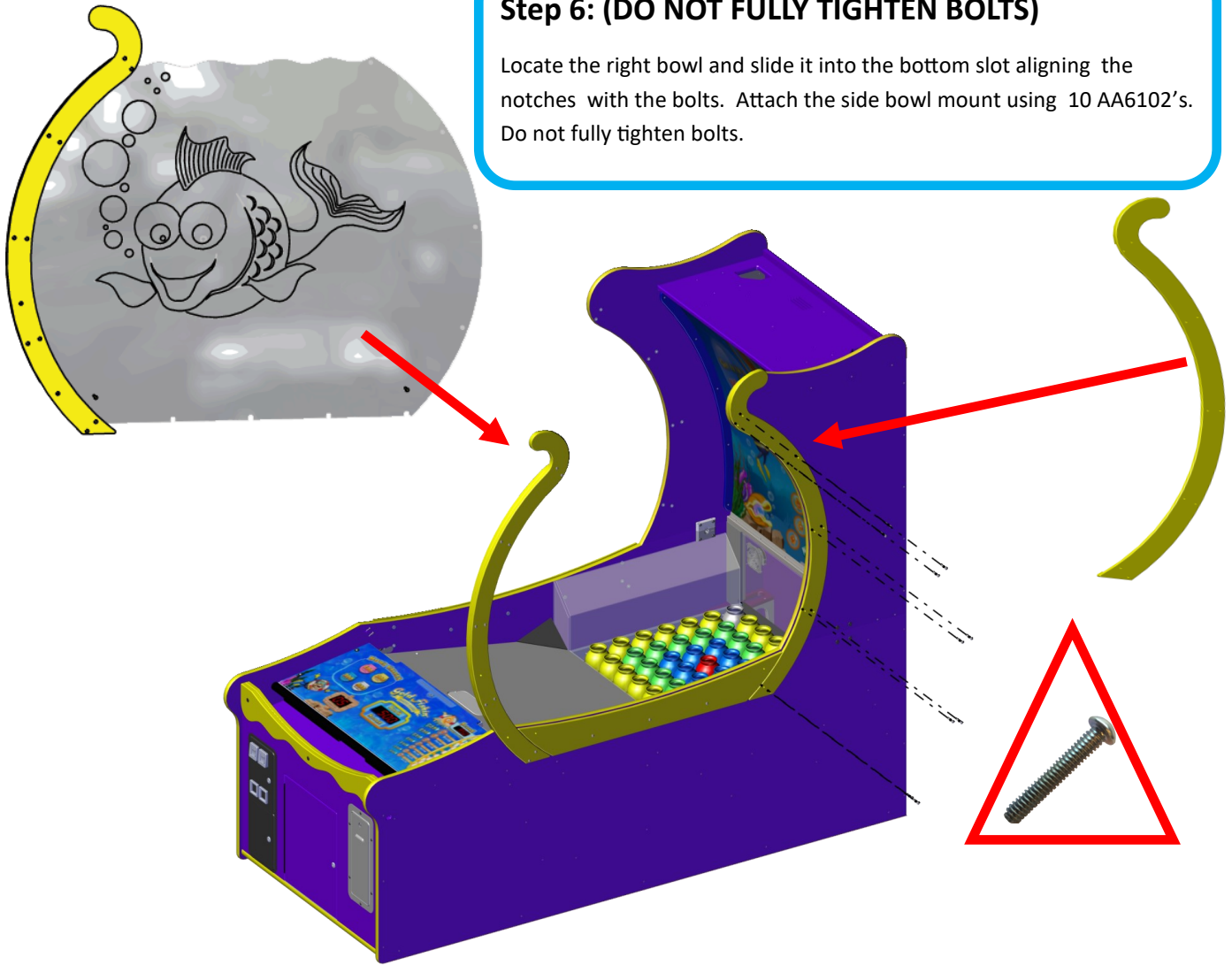

Step 7: (DO NOT FULLY TIGHTEN)

Use 2 AA6102's Allen bolts to attach the bottom of the bowl mount but do not fully tighten.

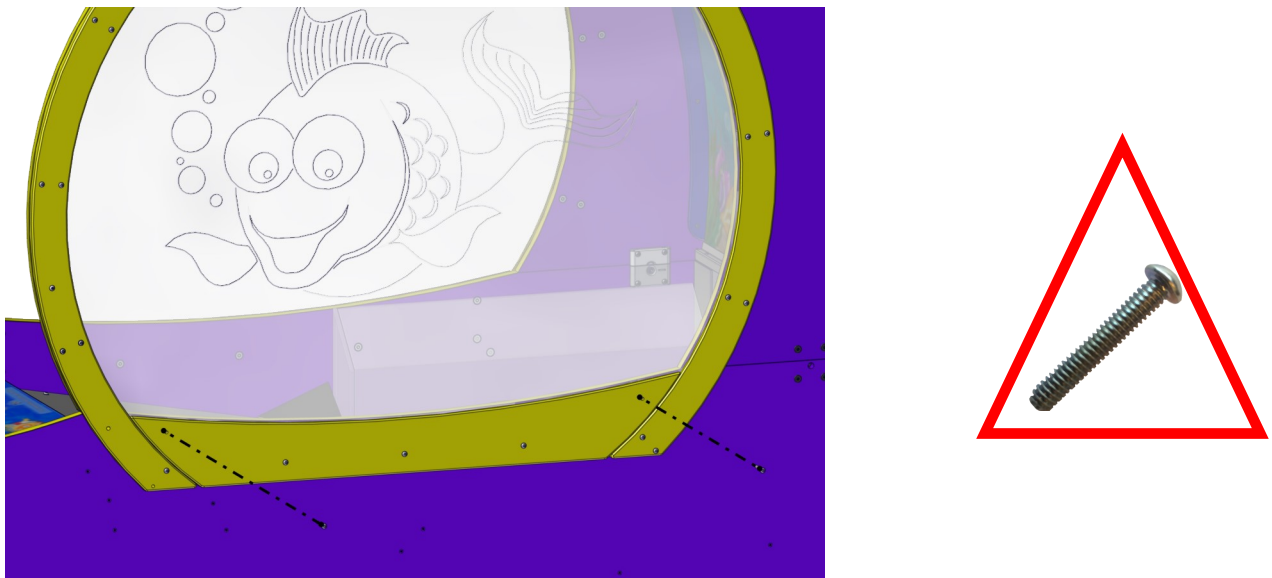



Step 8:

Repeat steps 4, 5, 6 and 7 for the left side. The etching should be on the inside when fully assembled.

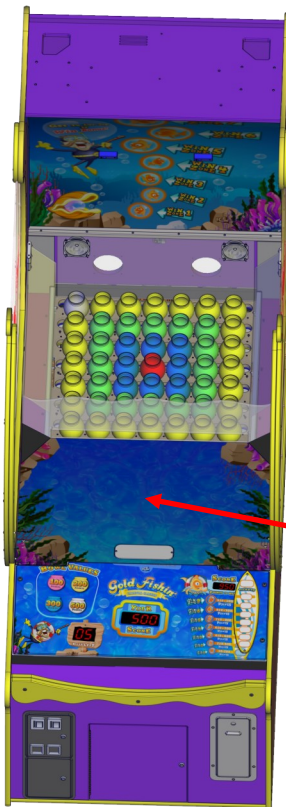

Step 9:

Remove ball ramp and put aside.

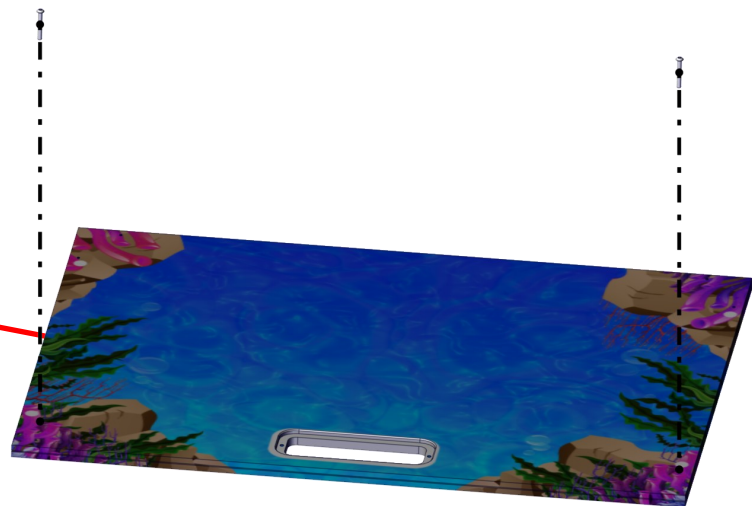



Step 10: (Not all games require this step)

Skip if the ball rebound guard is already attached to the yellow bracket. Position the yellow support for the ball rebound guard with the brackets facing the back of the game. Attach using four AA6719 Phillips screws.

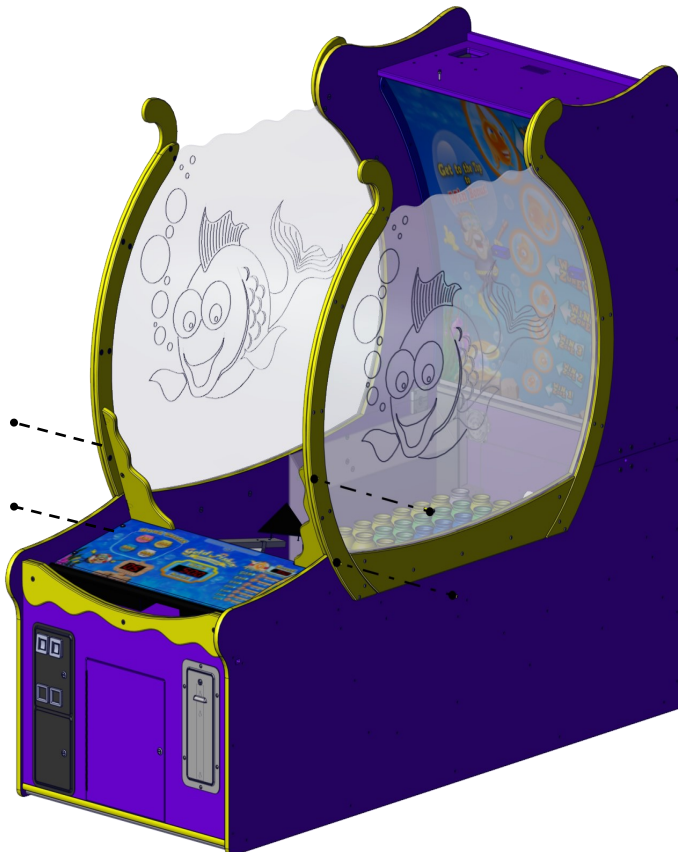
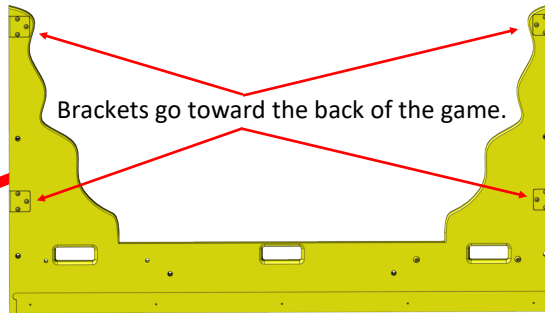

Step 11:

Attach the sides of the guard using four AA6102 silver Allen bolts, two on each side. The brackets face inside the game (See step 10 for illustration). Do not fully tighten until all four bolts are installed. Tighten the Phillips screws if installed in STEP 10. **** Tighten all bolts now. ****

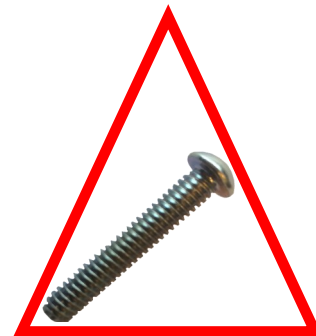

Step 12: (Not all games require this step)

If not already attached to the yellow front supports attach the clear ball bounce shield using 6 black AA6212 washers and 6 black AA6211 1/4-20 Bolts as shown below.



Step 13: (Not all games require this step)

Using AA6211 bolts attach the ball rebound guard assembly to the cabinet where circled.

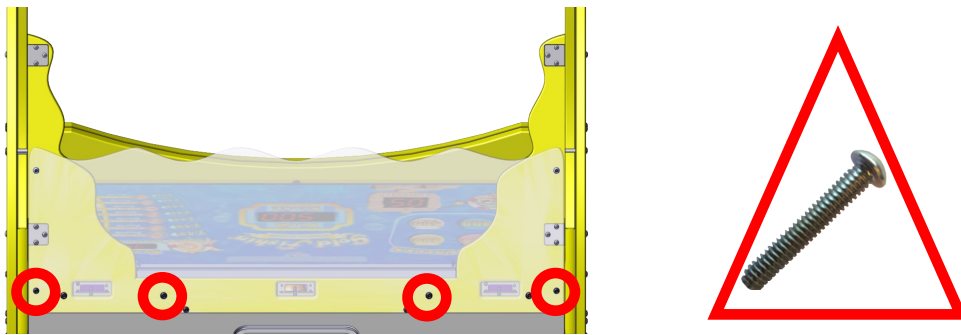

Step 14:

Replace the ball ramp that was put aside in step 9.



Step 15:

Attach the upper marquee using four silver AA6202 shoulder hex bolts and four AA6070 large silver washers.

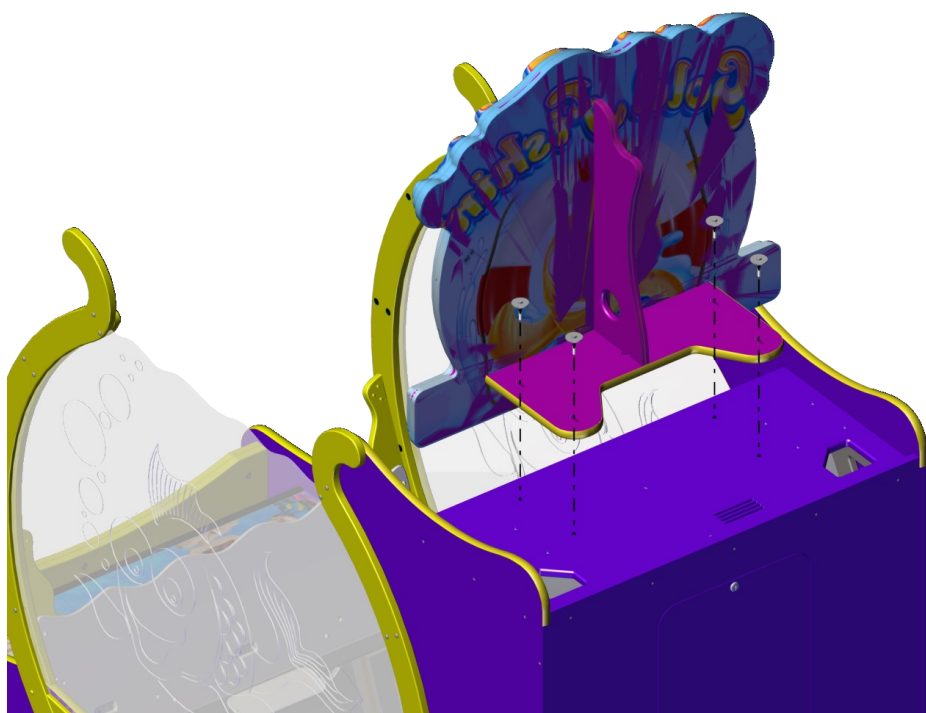

Step 16:

Plug the harness shown for the marquee. If not found, open the upper back door and locate the harness.

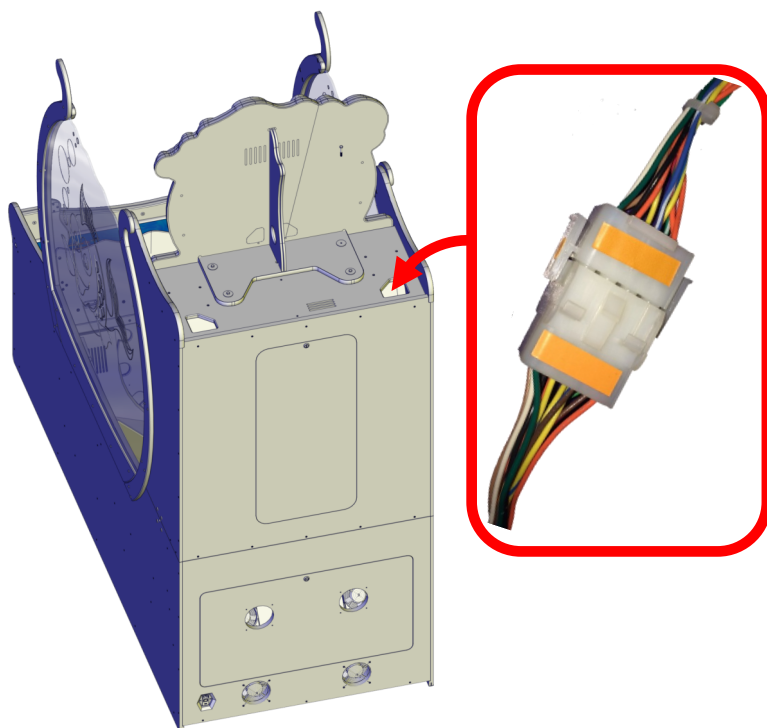

Step 17:

Located in the parts package are two bags of balls. Each bag contains 36 balls. It is recommended to add only one bag to the game. Dump the bag of balls onto the playfield cover.



Step 18: FINAL STEP

Also located in the parts package are the “Surf board” award ticket decals. Choose your desired ticket payout and install under the Surf Board on the control panel. See “Suggested Ticket Awards” for details.

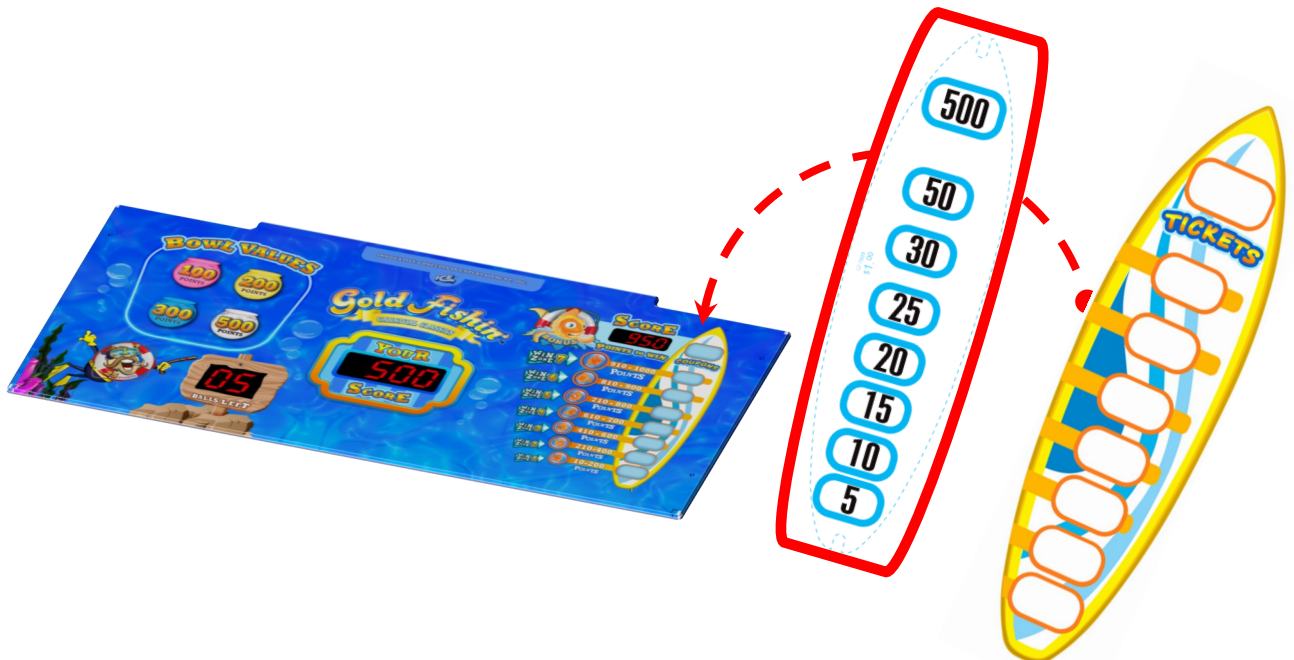

Gold Fishin Mega Marquee Instructions

Your Mega Marquee should have the follow items included.

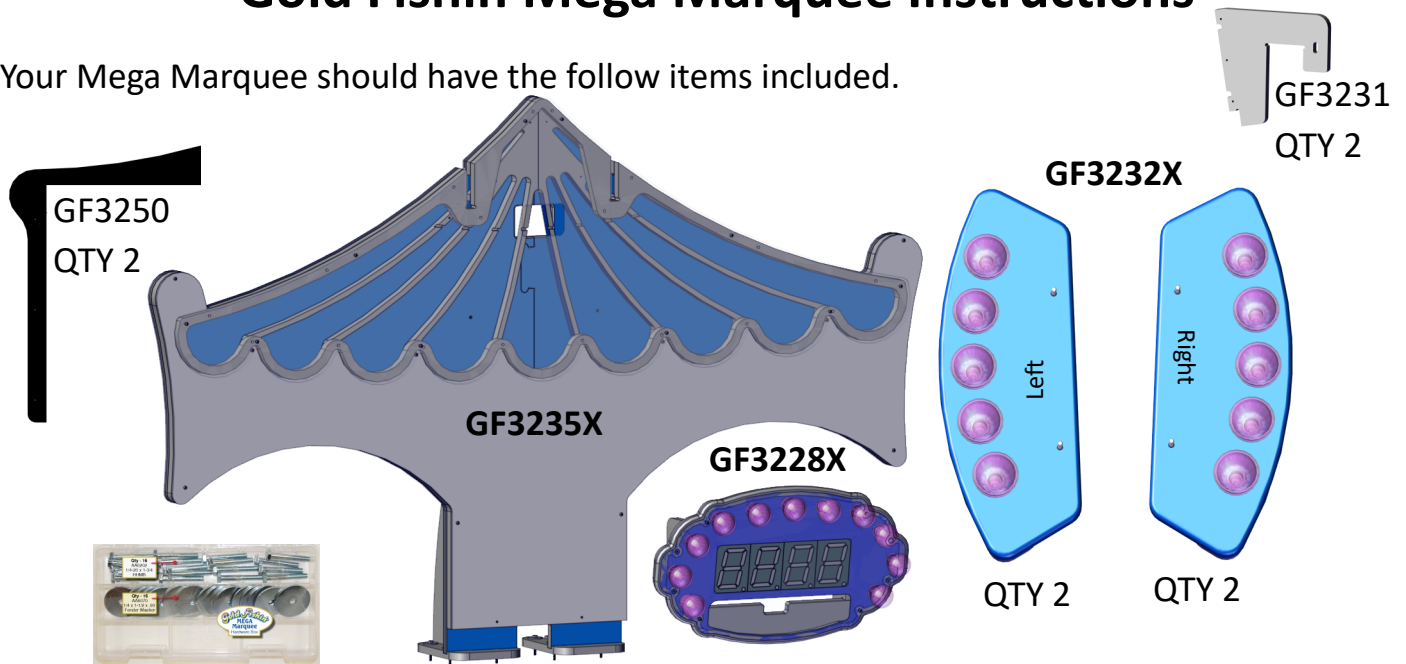

Step 1:

Attach the front spacer (GF3250) to each side of the cabinet that will face each other when pushed together. Use the provided wood screws to mount them to the cabinet. This will take up the gab between the two games.



Step 2:

Slide the two games together ensuring that the back is square to the front.



Step 3:

Install the bonus lights (GF3232X) onto the upper marquees of two games. There is a left GF3232X and a right GF3232X. The wire harnesses should all come out the bottom of the GF3232X's.

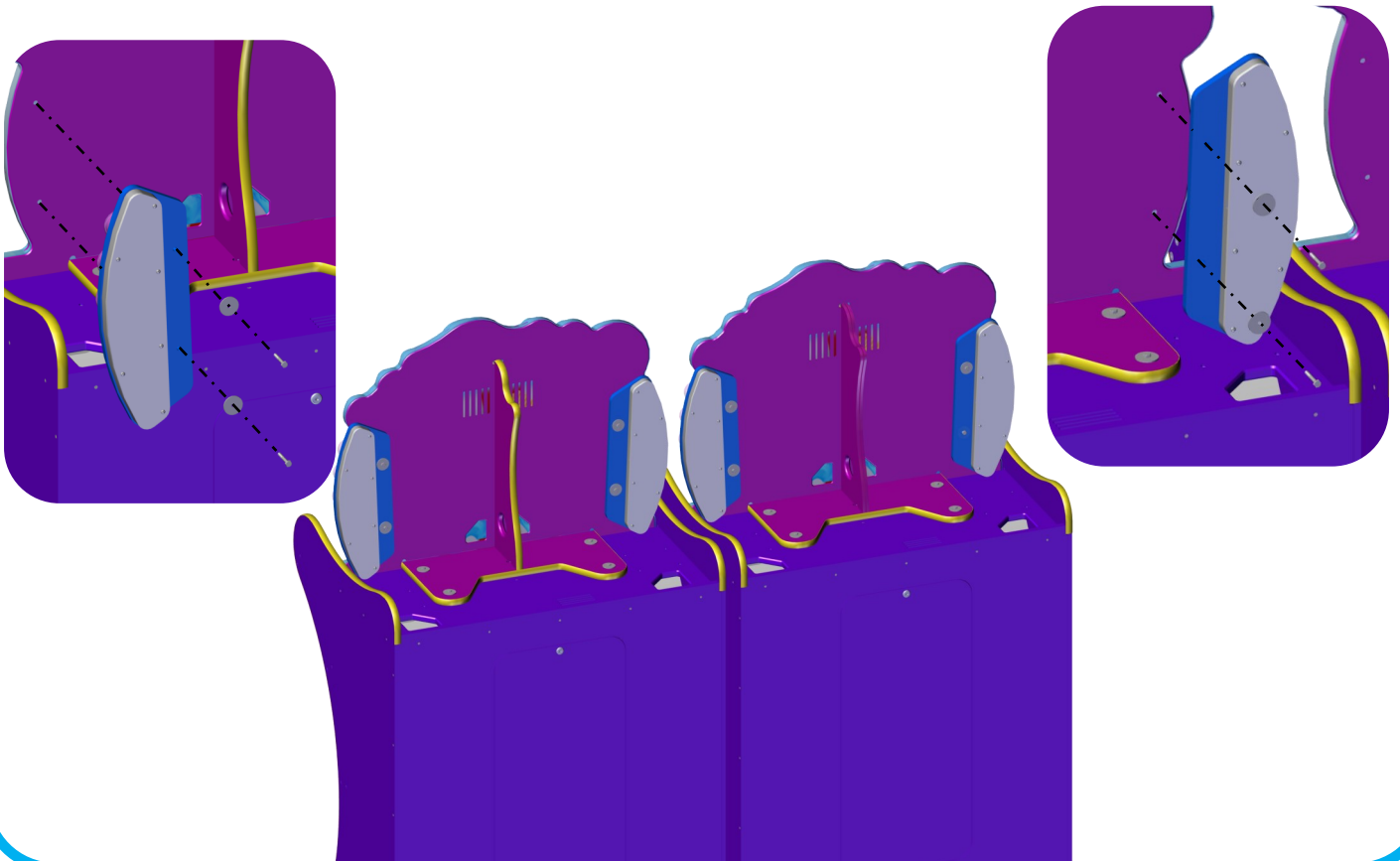

Step 4:

Carefully lift the main Mega Marquee (GF3235X) across two games top, behind the upper marquees. Using eight 6202 bolts and 6070 washers attach the assembly.

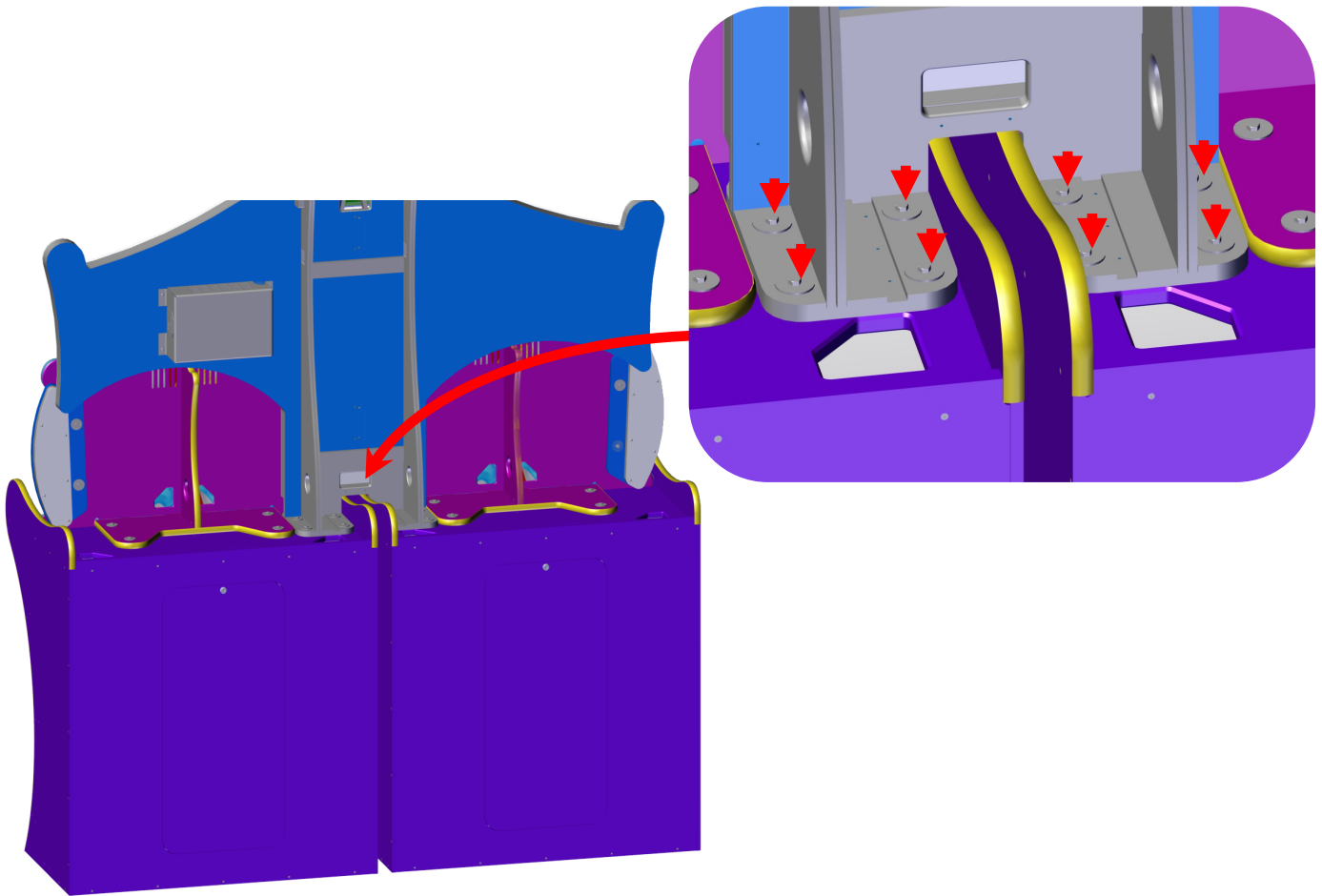

Step 5:a (Not all games require this step)

If your brackets are not attached to the sign, remove the four bolts holding the sign together and put them aside.

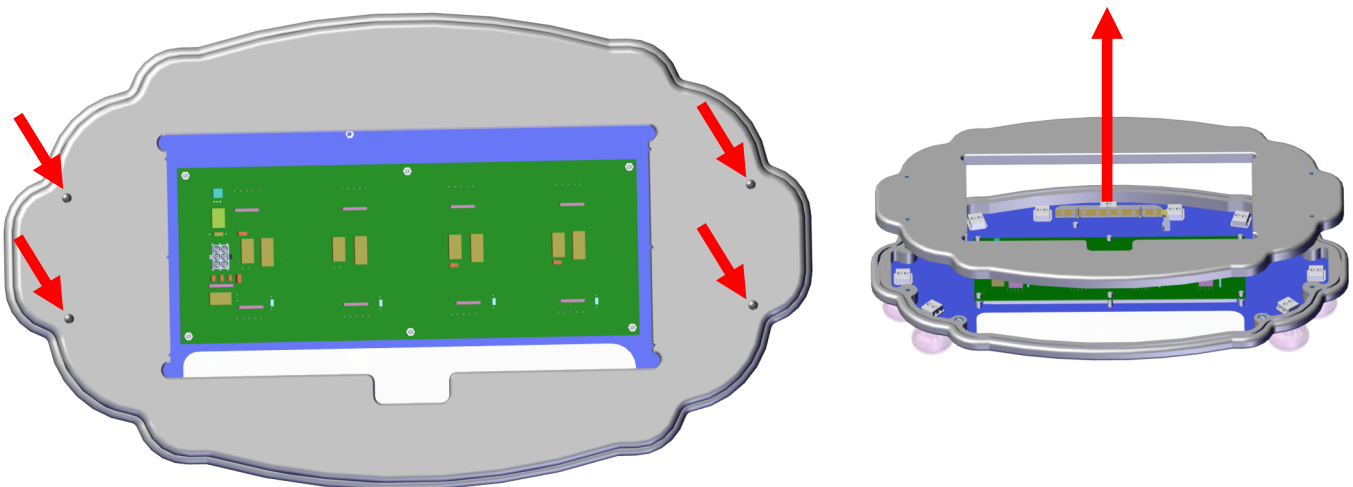

Step 5b: (Not all games require this step)

Attach the a GF3231 bracket to one side using 3 drywall screws. Repeat for the other side.

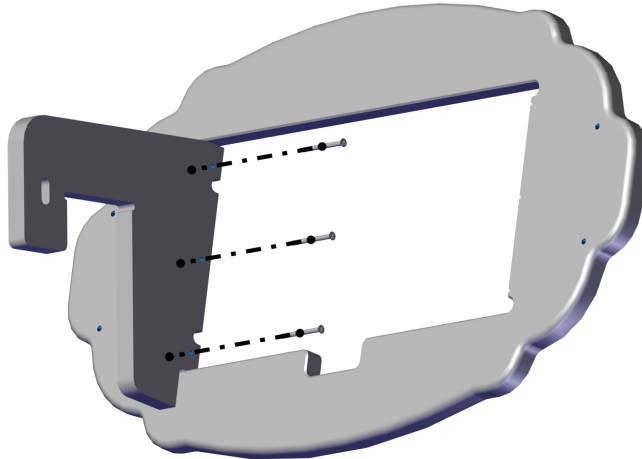

Step 5c: (Not all games require this step)

Reassemble the sign using the bolts you put aside in step 5a.

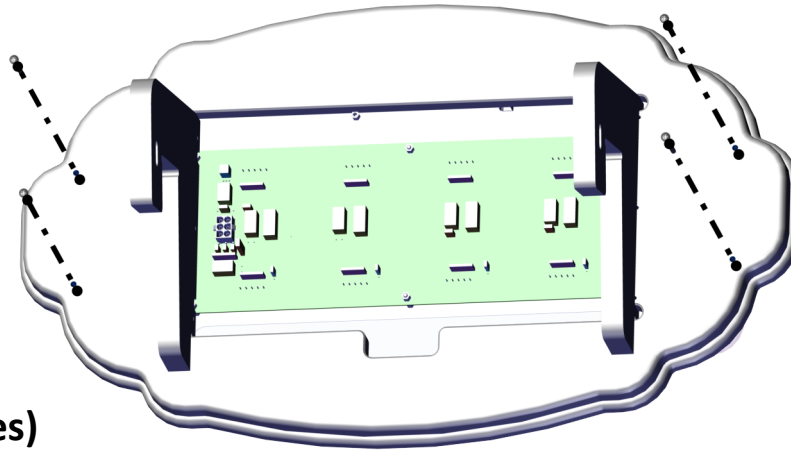

Step d: (All games)

Remove the two mounting bolts located at the top of the Mega Marquee. Slide the GF3228X display onto the top of the Mega Marquee. Attach the wire three harnesses. Secure with the two bolts you removed previously.

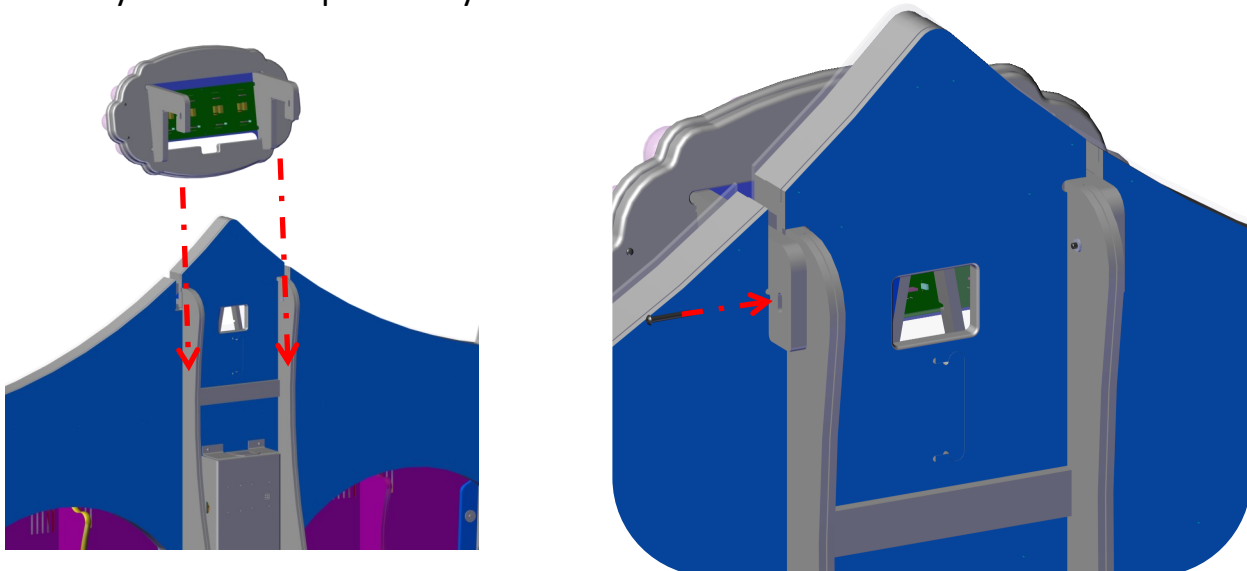

Step 6:

Connect the AC power cord to the Mega Marquee box. Connect the Bonus light harnesses to each GF3232X Light assemblies. A special communication cable should be run from the mega marquee, down through the bottom of one of the cabinets, to the main board's connector J30. On some units this cable is already installed in the cabinet. It would be coiled and secured to the bottom of the cabinet. It can be accessed by opening the lower cabinet door.

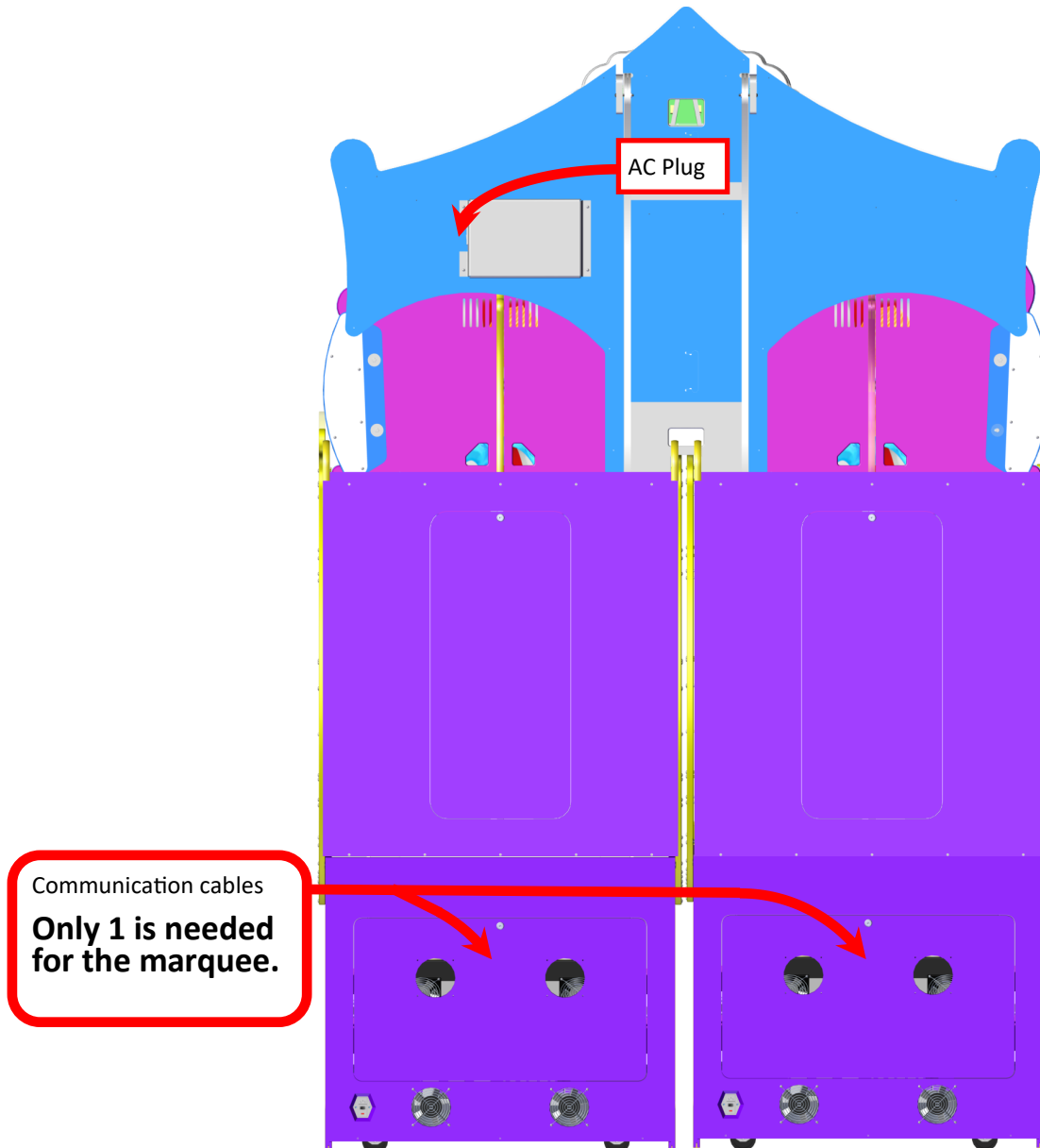

Marquee Setup Notes:

- Only 1 game should be linked to the upper sign. You do not connect the two games together.
- Display shows --- on the mega marquee until communication is established.
- Displays half of bonus value randomly - you linked both games together.

Changing Program Settings:

To enter program mode you must not be in the middle of a game. Open the upper coin door and press the “Program” button. The control panel will show the option number in the balls left display. Your score display shows the value stored for that option. Press the “Select” button to change options. Press the “UP” and “DOWN” buttons to change the option’s value.

See “Program Options” for option details.

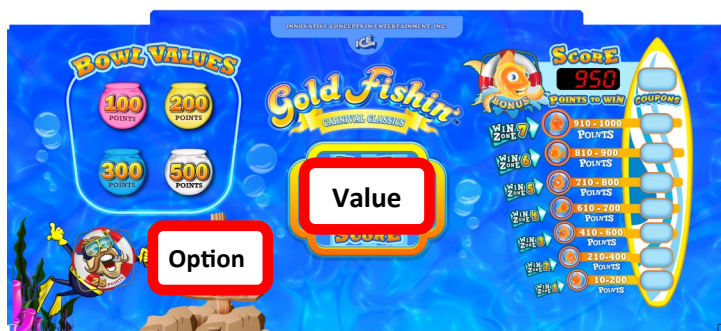

Accounting Mode:

To enter accounting mode you must not be in the middle of a game. Press the “Up” button located in the upper coin door. The game will show in the “ball’s left” display the current account number and in the “your score” display show the value. The game will cycle through all the account numbers and their values stored. To exit account mode without erasing the values press the “UP” button again. If you want to clear the accounting values, press the “Down” button.

See “Account Mode Table” for explanations of accounts.

Programming Options for Gold Fishin (1.10)

| Option | Min | Max | Default | Inc | Description |
|--------|-----|------|---------|-----|---|
| 0 | 0 | 7 | 5 | 1 | Game Volume Adjusts game sound effects. |
| 1 | 0 | 7 | 5 | 1 | Music Volume Adjust background music |
| 2 | 0 | 30 | 3 | 1 | Attract Time Adjusts how often the game will play attract sounds. |
| 3 | 0 | 20 | 1 | 1 | Cost of Game in pulses How many pulses of coin 1 to start the game? |
| 4 | 0 | 20 | 1 | 1 | Coin 2 Value in Coin 1 increments How many of coin 1 is coin line 2 worth? Used in setting up different valued coins. |
| 5 | 10 | 20 | 12 | 1 | Number of Balls Per Game How many balls are given per game. |
| 6 | 0 | 2 | 1 | 1 | Ticket Multiplier sets how the game will pay tickets owed. A value of 0 will pay 0 tickets for each ticket owed. A value of 1 will pay 1 ticket for each ticket owed. A value of 2 will pay 1/2 a ticket for each ticket owed. |
| 7 | 0 | 100 | 20 | 1 | Ball Timeout defines how long to wait before subtracting a ball from play. |
| 8 | 0 | 100 | 1 | 1 | Tickets given for a score between 10 - 200 |
| 9 | 0 | 100 | 2 | 1 | Tickets given for a score between 210 - 400 |
| 10 | 0 | 100 | 3 | 1 | Tickets given for a score between 410 - 600 |
| 11 | 0 | 100 | 4 | 1 | Tickets given for a score between 610 - 700 |
| 12 | 0 | 100 | 5 | 1 | Tickets given for a score between 710 - 800 |
| 13 | 0 | 100 | 8 | 1 | Tickets given for a score between 810 - 900 |
| 14 | 0 | 200 | 10 | 1 | Tickets given for a score between 910 - 1000 |
| 15 | 0 | 5000 | 250 | 25 | Tickets given for winning the Bonus |
| 16 | 0 | 200 | 100 | 1 | Add these many points to the score to beat when bonus is won. |
| 17 | 0 | 200 | 5 | 1 | Subtract these many points each time the bonus is not won. |
| 18 | 0 | 50 | 0 | 1 | Setting a value will only pay these many tickets regardless of points. |
| 19 | 0 | 1 | 100 | 75 | The lower the value the more sensitive the cheat sensor. A setting of 0 disables the cheat sensor. |
| 20 | 0 | 1 | 0 | 1 | Factory Reset |

Options that need to be set:

- Option 3, Cost of Game – How many pulses to start the game?
- Options 8 through 14 – Slot values, how many tickets to give for each level achieved.
- Option 15 – Bonus tickets amount.

Options that can alter the average tickets out:

- Option 5, Number of balls given per game. Normally we like this one to be 12.
- Option 16 and 17 – Increment and decrement points needed to win the bonus.

- A note on option 19 – Older versions of software only allowed a setting of 0 or 1, on or off.

Suggested Ticket Awards

\$0.50 Game
GF7004

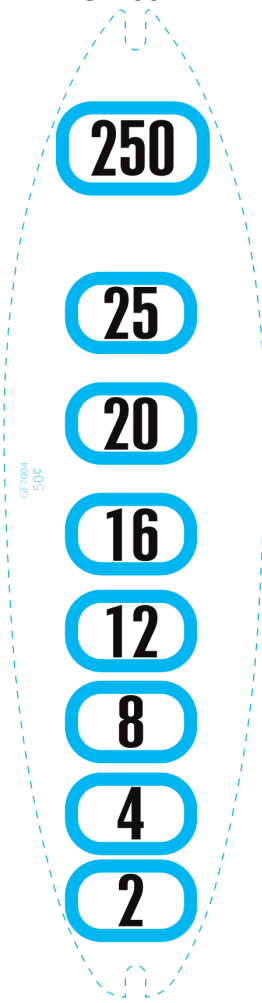

\$1.00 Game
GF7008

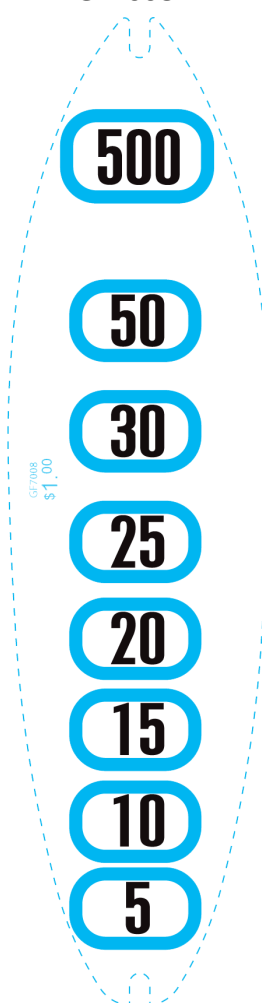

\$1.50 Game
GF7009

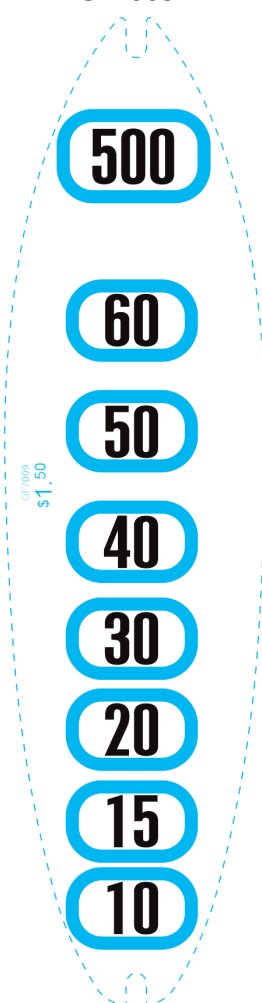

\$2.00 Game
GF7016

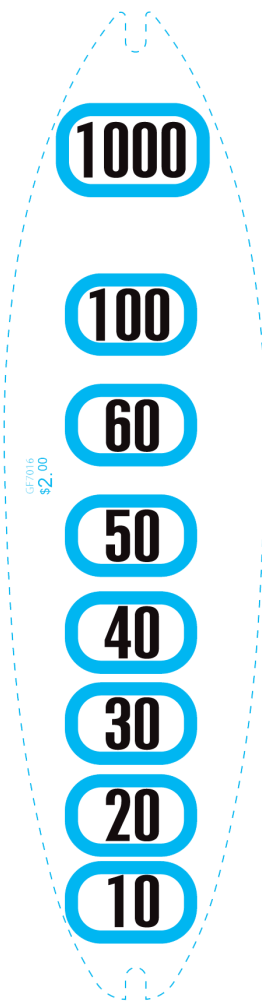

Audit Mode

The game can display various audit information about its game play. To display this information, open the upper coin door and press the up button when not in a game. The "Balls Left" display will show you which audit it is displaying while the "Your Score" display will show how many times it was made. The "Tickets to Win" display will show "ACCR" during the audit process. To exit audits, press the up button again. If you want to clear the stored audits, press the down button while the accounting mode is displaying. The "Tickets to Win" display will show "CL", pause and exit when it has completed erasing all audits.

| Audit # | Description |
|---------|-------------|
| 1 | Bonus Won |
| 2 | Tilts |
| 3 | 0-99 |
| 4 | 100-199 |
| 5 | 200-299 |
| 6 | 300-399 |
| 7 | 400-499 |
| 8 | 500-599 |
| 9 | 600-699 |
| 10 | 700-799 |
| 11 | 800-899 |
| 12 | 900-999 |
| 13 | 1000-1099 |
| 14 | 1100-1199 |
| 15 | 1200-1299 |
| 16 | 1300-1399 |
| 17 | 1400-1499 |
| 18 | 1500-1599 |
| 19 | 1600-1699 |
| 20 | 1700-1799 |
| 21 | 1800-1899 |
| 22 | 1900-1999 |
| 23 | 2000+ |



Service: Removing the Ball Ramp

Loosen the two Allen bolts shown below. Make sure they are not securing the ball ramp and use them to pry the panel up and over the front ball deflector.



Service: Removing a Fish Bowl

To remove a fish bowl, twist counter clock-wise. The O-ring at the bottom of the bowl keeps the bowl from loosening during game play. Do not add any lubrication to the O-ring. Doing so can result in damage to the sensor board below.

To Install, align the notches at the board and twist clock-wise.

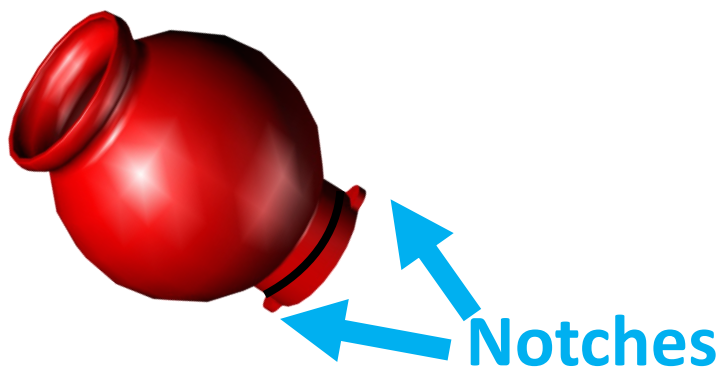
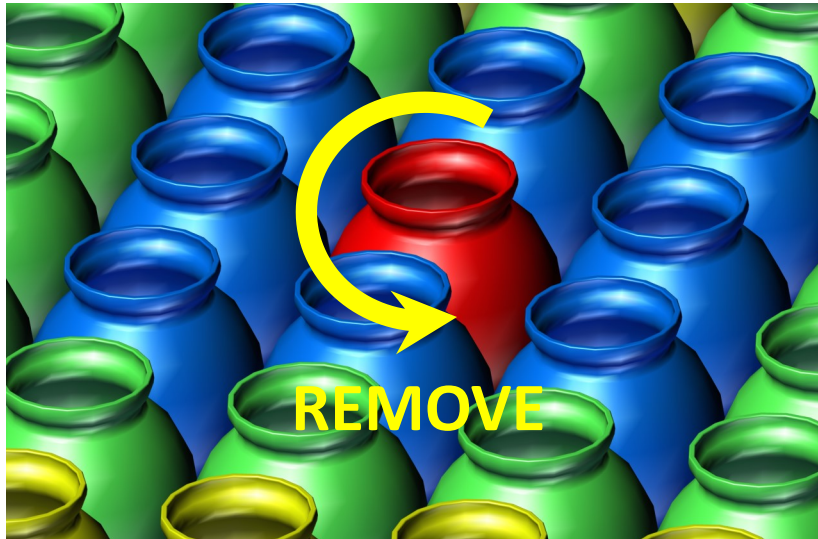

Service: Accessing the Sensors:

Remove the ball ramp and put aside. See "Removing the Ball Ramp". Loosen the four Allen bolts that secure the side ball deflectors. Remove the bowl in front of the bolt if tight. See "Removing a Fish Bowl" for details. Pull the top of the side ball deflectors slightly toward the center of the cabinet and then straight up and out. Fully lift the playfield up.

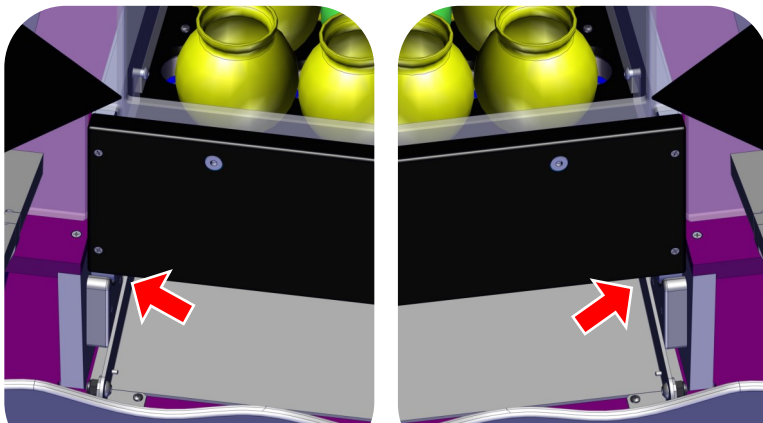
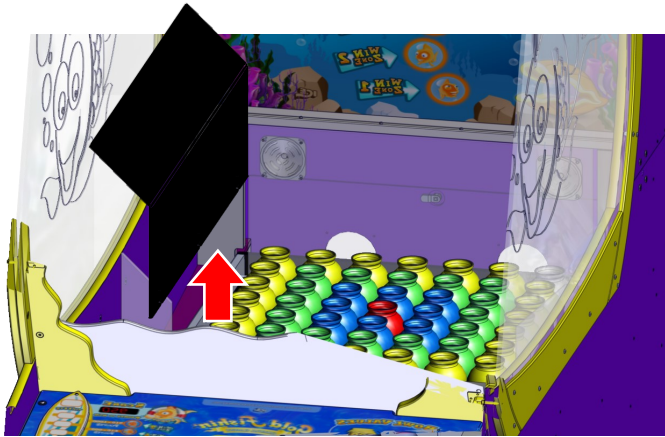
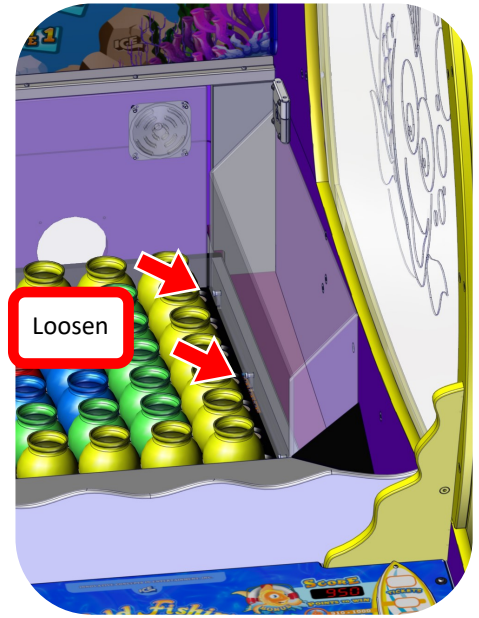
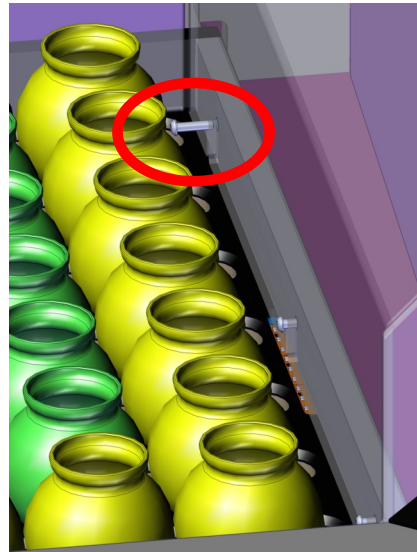
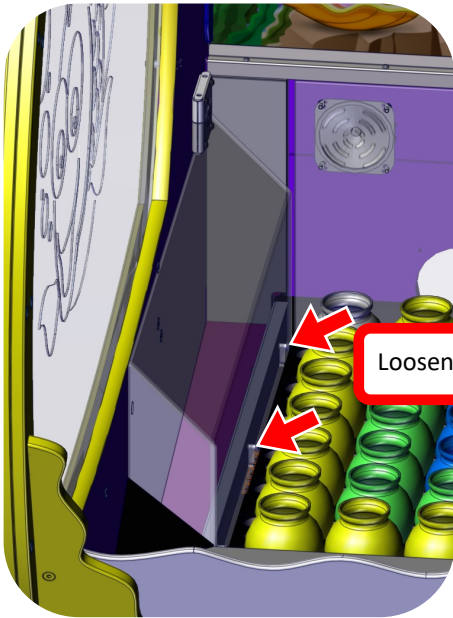

SOME UNITS HAVE LOCKING BOLTS OR PINS



Sensor Layout

The playfield uses 3 different styles of sensors mounted in different rotations depending on where the sensor is mounted. GF2040X, GF2039X, and GF2041X. The picture below shows the proper order and rotation of each sensor board. You can use the same style of sensor at any location. When the game is first powered on, each sensor will numerate itself to the location it is installed. As each sensor numerates, the color of the fish bowl (on top) will change to green. This indicates that the sensor has assigned itself an ID number for its location and then it will transmit this ID number to the game. This is displayed in the "Balls left" display on the control panel. When the game completes this process it will begin it's attract mode and await for coinage to start. If this process doesn't complete the last reported sensor ID will be displayed on the "Balls left" display.

See "Rotary Diagnostic Modes, mode 7" for trouble shooting information.

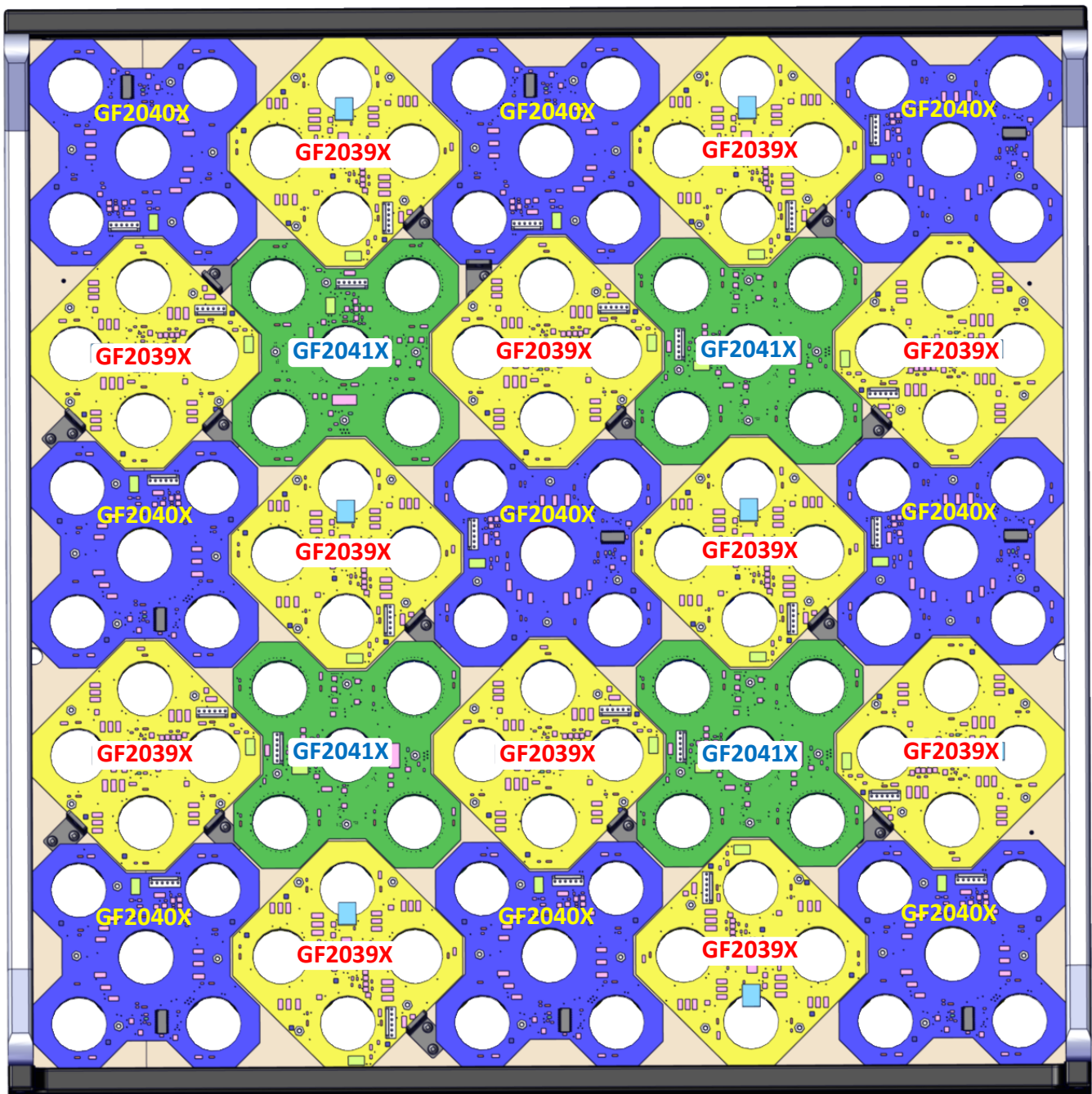

Serial Debug Port

Game Port Diagnostic Connection:

To use the Port Diagnostic connection you must connect an additional cable that provides a standard serial port connection to a PC. The part number is GF2098LX. The computer must have a serial port and a terminal program installed before using this feature. You can download free terminal software from the internet if you do not have a terminal program already installed on your computer. The program "Putty" from www.putty.org can be downloaded for free and is a good terminal program to use. You will also need to obtain a RS232 serial cable to go between your computer's serial port and the game's serial port. If the computer has no serial ports, the use of a serial to USB device is recommended.

The game's serial port is located on the main board at J29, right of the CPU sub board. You will need to order ICE part number GF2098LX serial interface cable in order to attach a standard RS232 serial cable from you. Once the serial cable is connected launch your terminal program and configure the software to use a serial connection. The baud rate is 115200 kbs and uses 8 bits with no parity bit with 1 stop bit.

Once the connection is established you will see numbers and letters being displayed as the game is being played. The following list defines the meaning of those letters and numbers.

When a "B" is displayed this means it is a start of a game. A "D" is displayed when the "Ball Dispense Switch" has been made and a ball has been dispensed. A "S" followed by numbers in this format "##.#" means "##." is the score board number and ".#" is the score sensor number. If a "C" is displayed then the game detected a cheat attempt and tilted the game. A "G" means "Give Balls" and turn on the Ball Dispense Motor. Anytime a "E" is shown means that the ball timeout occurred and the ball count left to play is reduced. A "V" means game over.

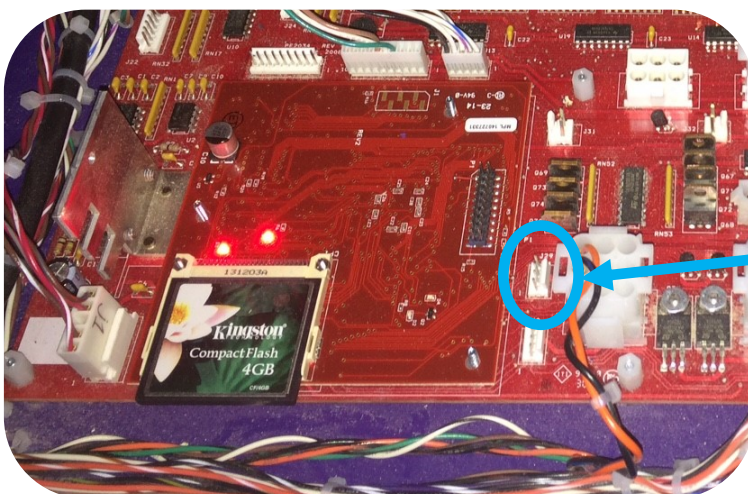
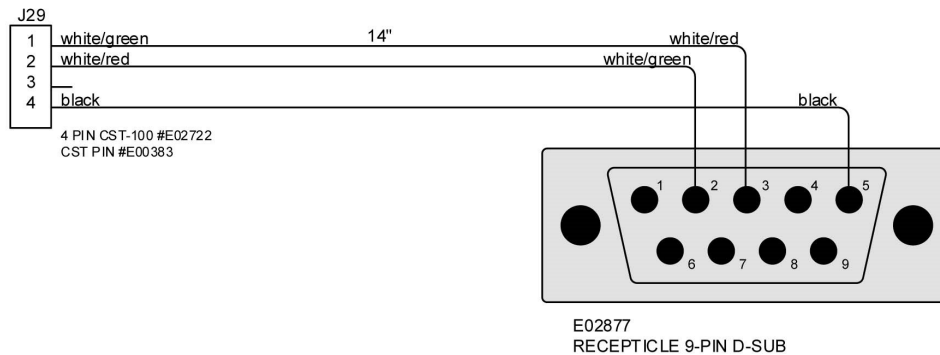

J29 serial connection
for GF2098LX.

Rotary Diagnostic Modes

Located on the main board is a rotary switch. A small triangle points to numbered position. This is normally 0 and is the standard game mode position. Turning this will run different tests. The score display will display a "C" followed by the diagnostic mode number. The exception to this is position 6. To exit out of at any of these modes simply rotate the switch back to the 0 position.

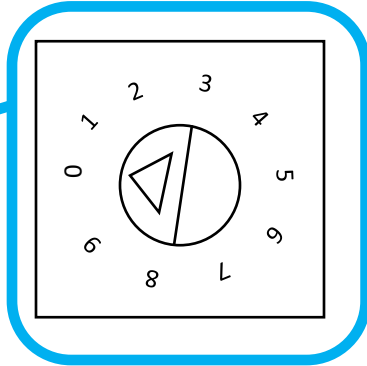
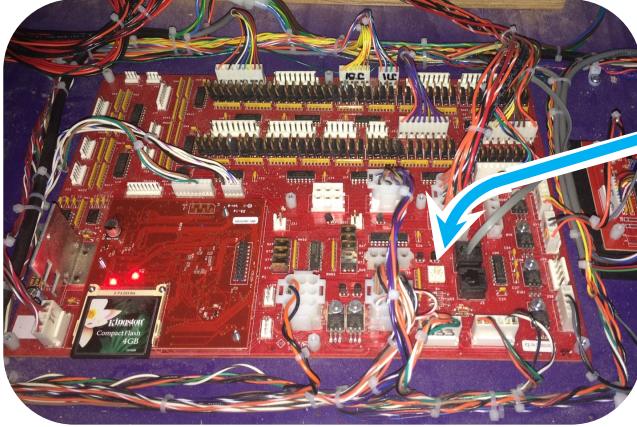

Position 1 [Color Lock] : This mode will stop the game after sensor board enumeration so that you can see the colors that the sensor board has displayed. This mode can only be enabled during power up sequence.

Position 2 [Test Holes Dark] : This mode allows you to throw balls onto the playfield. The bowls for each board shall light up green if that board has sensed a ball. A time out will occur if no other ball has been sensed returning the bowl(s) to dark state again. If however a second sense for the same hole has occurred before the timeout, then RED shall be displayed for that board. Since there is not a correlation of holes to lights all the boards bowls will light regardless of which sensor on that board was the culprit. If physically 2 balls enter the same hole before the timeout, than the board will light RED even though that is a valid condition. It is up to the operator to determine if the red is legitimate or not. The last RED bowl shall be indicated by the target score display of xxyy with xx = board ID, yy = sensor number. Valid board ID's are 1-25, and Sensor ID's are 1-5.

Position 3 [Test Hole Light] : This mode is the same as the mode above, only instead of the bowls being off and turning red or green, they are white turning red or green as appropriate.

Position 4 [Test Playfield Lights] : This mode will turn on the bowl lights in and RGB fashion to determine if one or more colors are not working for a specific bowl. The colors are Red, than both Red and Green, and finally Red, Green, and Blue all together. The ball display will show which light it is that is currently being changed.

Position 5 [Cheat Sensor] : This will light the Bonus Tickets light based on the state of the cheat sensor. If the cheat sensor is clear (not blocked) then the light will be on, if blocked the light will be off.

Position 6 [Burn in] : This mode is similar to attract with the addition of all the segments displaying 0-9 cycling, and the appropriate game balls will attempt to dispense each cycle of the numbers and Audio will cycle

Position 7 [Board ID] : This mode will cycle the board ID of 1-25 and send the command to that board to light the LED's. The ball display will show which ID it is lighting. Should a board have the wrong enumeration, this should allow that to be identified. - Board ID is the only mode that will exit enumeration mode early, this allows you to identify which board(s) are not functioning appropriately. Remember that you need to let the enumeration process stop before selecting this or you will stop the enumeration mode early and unknown results may occur.

Test Mode NOTES: A small rotary switch on the main board puts the game in either a test mode or game mode.

- Although it has 10 positions, only 8 are used.
- Position 5 is good to test the functions of the cheat sensor.
- Position 6 puts the game into a "factory burn in" mode to test all functions of the game.
- Position 7 is used when the game will not enumerate correctly – more on that later.

Ball Dispenser Motor Removal

Step 1:

Remove the four screws holding the ball dispensing wheel.

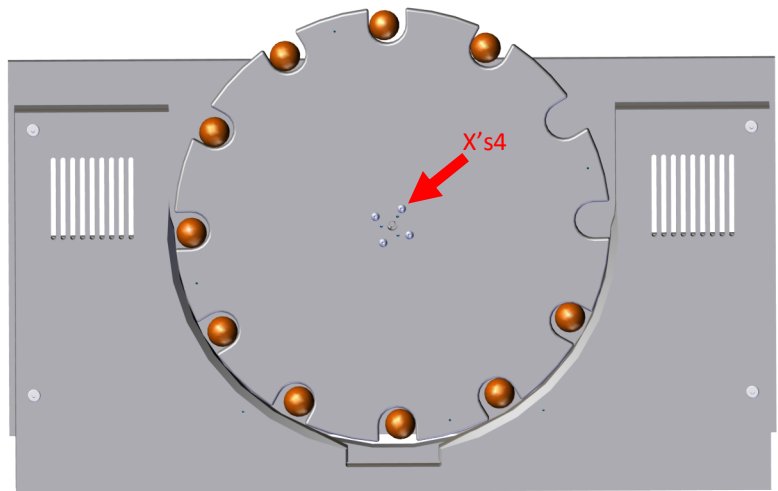
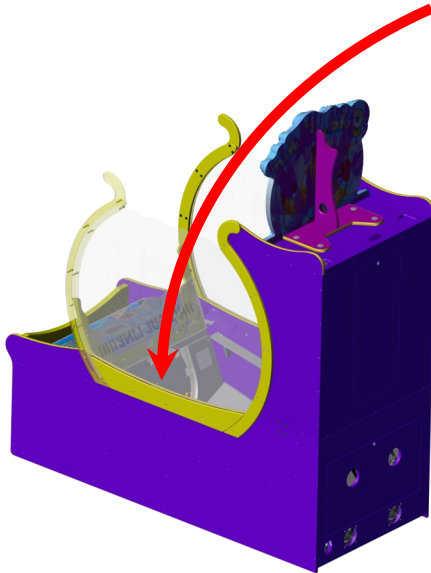

Step 2:

Then remove the four holding the motor to the motor mount. Unplug harness and remove through front access door.

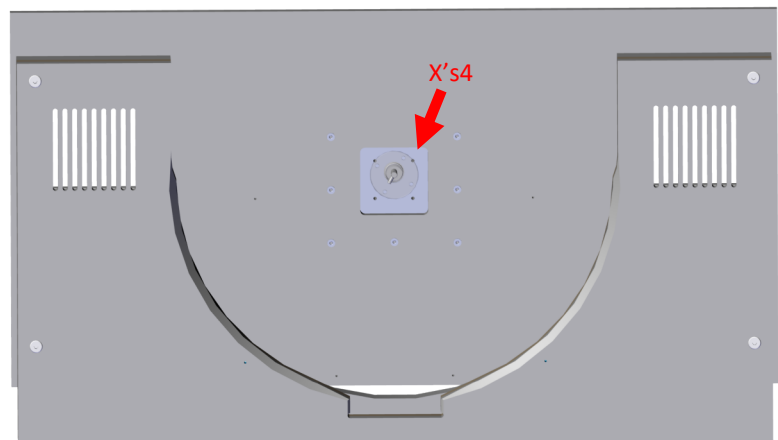
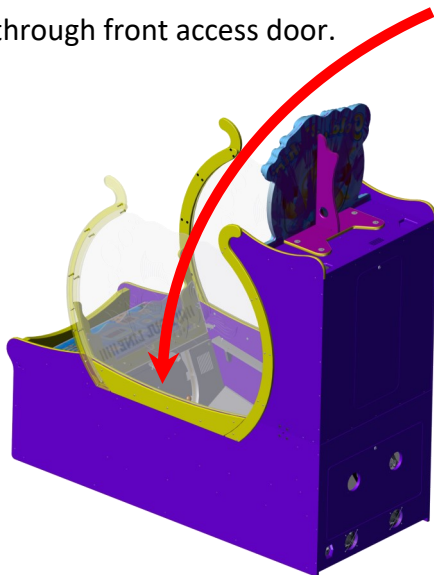

Technical Information

The Gold Fishing game uses an enumeration process at power on to identify each sensors position to the main board. This process will allow each sensor to address itself with its own identification number and report that to the game board. When the game is first turned on you will notice the display counting from 1 through 25. When a sensor enumerates, it reports what is its address to the game board through the serial data (all score sensor listen to this information too). This is what is displayed when the game is showing 1 through 25 that is the last sensor address that was reported. They will turn either Green (sensor tested good and enumerated), Yellow (sensor tested weak and enumerated), or Red (Sensor is bad but enumerated) during the Enumeration process.

We use three different types of sensor boards in the playfield. These sensor boards are only interchangeable with the same type. Each sensor board has a six pin plug. The pinout is below.

- **Note 1:** Pins 2 and 3 will have 5vdc until it passes the enumeration process. When the game recognizes the sensor this 5vdc will drop to 0vdc.
- **Note 2:** Sensor 1 input release is always held low at 0vdc to start the enumeration process
- **Note 3:** You will also notice the red led on the bottom of the board (D6) is study light until it had assigned an I.D. This light will flash like a heartbeat when it is enumerated. Pins 2 and three will have 5vdc until it passes the enumeration process. When the game recognizes the sensor this 5vdc will drop to 0vdc.
- **Note 4:** Low power conditions or dropping power supplies will cause the enumeration process to reset

Pin 1 is the serial data (green) and is common to all sensor and main board.

Pin 2 is the output release

Pin 3 is the Input release

Pin 4 is your 12vdc (orange)

Pin 5 is your ground (black)

Pin 6 is your 5vdc (red)

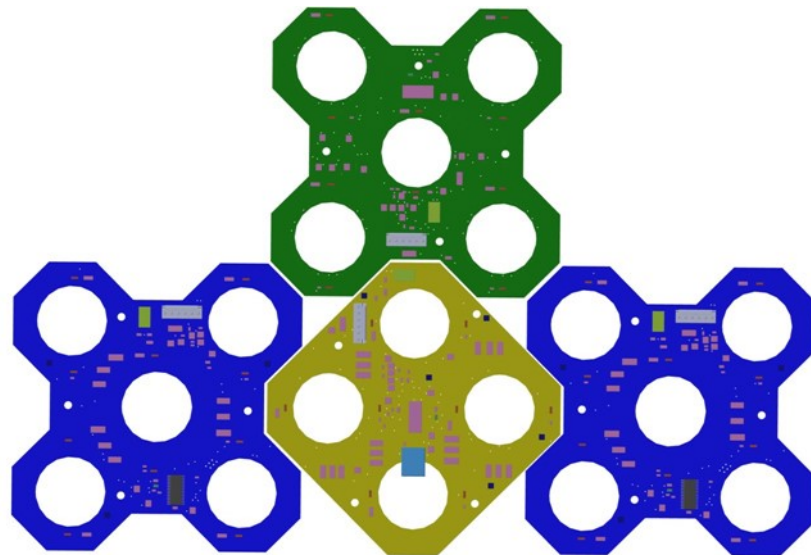
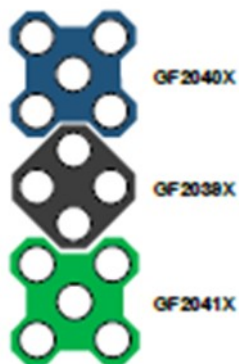

For example:

If sensor 5 has a faulty input, the game will stop counting at 4. (as sensor 5 was not found).

If sensor 5 has a faulty output, the game will stop counting at 5. (as sensor 5 did not allow sensor 6 to communicate).

• **When playfield sensors won't enumerate**

- 1) Turn the game off, and then back on.
- 2) Wait for the sensors to light as the display counts its way up to 25. If there is a sensor issue the game will hang at the highest sensor that it can assign a number to.
- 3) Once the game is hanging on a number/score hole, turn the rotary switch to seven.
 - A. Watch the sensors light one led board at a time.
 - B. Any sensors that double light are questionable and need to be swapped with a known good sensor.
 - C. Replace the sensor that is double lighting if the problem followed that sensor.
 - D. If the problem is not that sensor swap the sensor prior to the one that is double lighting as it may be a faulty signal leaving the prior board into the board that is double lighting.
 - E. Replace the faulty sensor that is sending a bad signal out to double light the faulty board.
- 4) Lift the playfield up and view the sensors from the bottom of the playfield. Each sensor board will have a red led (D6) light upon startup. When a sensor is found it will flash red. If the red led doesn't light it may be missing power. If it stays solid, then it is not found by the system.
 - A. Check power going to the sensor.
 - B. Swap J2 to J3
 - C. Replace main board

• **Enumeration process resetting:**

- 1) Check 12v at power supply - make sure it is not resetting.
- 2) Check the input voltage to the sensor after last sensor that properly enumerated (i.e. if the game counts 1, 2, 3, and then resets check the voltage at sensor 4)
- 3) Swap the sensor after last sensor that properly enumerated
- 4) By pass the last sensor to see if the enumeration process continues (i.e. if the game counts 1, 2, 3, and then resets, bypass 4)
 - A. To bypass a sensor, unplug the sensor that you wish to bypass
 - B. On the sensor prior to the bypassed sensor attach a wire on pin 2
 - C. On the sensor after the bypassed sensor connect the wire (from step b) to pin 3
 - D. Turn the game on if the game progresses further in the enumeration process then there is a break in the harness.

• **Enumeration process stopping at 24:**

- 1) Check for low power condition to the last few sensors.
- 2) Turn the rotary switch to 7.
 - A. Watch the sensor light and display their ID.
 - B. If 24 and 25 both light as 24 then run additional ground, +5, and +12 wires to last sensor board (25).
 - C. Turn rotary switch back to 0 and power cycle the game.

- **Cheat sensor troubleshooting. What does 7L17 mean?**

The Gold fishing game uses an infrared cheat system. It is designed to react if a player reaches across the foul line and breaks the beam for approximately 2 to 3 seconds. This delay can be programmed in the software under option 19. The system works by having two boards at the rear of the game called transmitters. Their function is to send a signal or beam across the games' playfield. This beam is seen by 3 receiver boards which are located below the foul line and inside of the game. These receiver boards see the beam and report to a small circuit board which interprets the three sensors and reports the status back to the games main circuit board.

Programming option 19 allows you to adjust the duration that the cheat sensor must be activated to trigger a cheat, the range for this value is 0 -100. Setting the value to 0 will disable the cheat sensor, values of 1 -100 effect how long the sensor must be blocked before a cheat is triggered in the software. A setting of 1 is the most sensitive and a setting of 100 is the least sensitive.

- **Checking the cheat sensor transmitters:**

The transmitters located at the back of the game are 5VDC devices. They are pulsed off and on by the cheat sensor board. On the sensor's 2 pin connector you will see +5vdc with minor fluctuations. You can also use an IR detector or low res digital camera to see that the transmitter LEDs are on and operational. You can check the connections for the transmitters to J4 on the cheat sensor board.

- **Checking the cheat sensor receivers:**

Each receiver board has a 3 pin connector. Pin 1 is 12vdc power, pin 2 is DC ground, and pin 3 is the cheat signal line. The sensor signal for the left and right receivers will be +2.5vdc when inactive and go to +5vdc when the receiver is blocked. The center sensor will have at pin 3 0vdc when inactive and go to +5vdc when blocked. You can check these signals on the J2 connector on the cheat main board.

- **Cheat sensor board (MJ2040X):**

The cheat sensor board interprets the incoming signals and then outputs all three signal as one to the main board. The connector at J1 is the input power, you should have +12vdc between the orange and black wire. The signal line from the cheat board to the main board is located on connector J4 pin 2, you should see 0vdc when the receivers are inactive and +5vdc when the receivers are blocked. The signal from the cheat sensor board connects to the main board at connector J27 pin 3. The cheat main board has a LED indicator at location D1. Normal operation for the LED is constantly flashing.

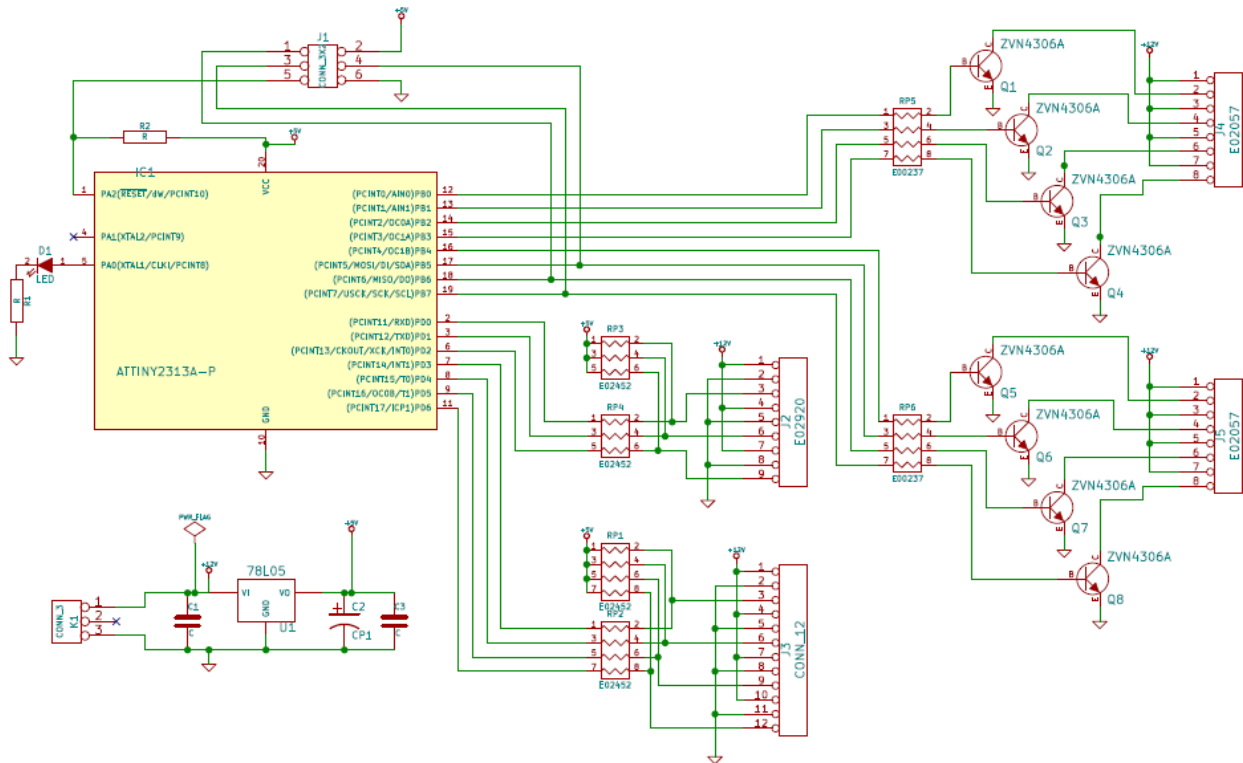

Ball dispense Assembly

1. Ball count switch is at the top of the ball exit hole.
2. Motor w/poly fuse - will fail if large wheel is hand turned.
3. Motor will spin during game play until all 12 (or what ball count is set to) balls are dispensed.
4. DO NOT LOAD more than 36 balls into the game, it will cause them to create a V and jam.
5. Ball dispenses one too many balls every time - Bracket that switch is mounted to is flipped.

Fish Bowls

1. Do not use lubrication on the O-rings (we pre-dip them in Boe-lube).
2. Other lubricates attack the rubber and cause "Dry Out" condition.
3. Missing O-rings causes bowls to come loose during play.
4. Twist to lock and unlock
5. Plastic insert in the center of bowl prevents larger balls and two balls from entering at once.

Spare Parts List

Electronics:

| | |
|-------------|--------------------------------------|
| PE2034X | Main i/o board (no CPU) |
| E2034XX | Brain Board w/flash |
| MJ2040X | Cheat controller |
| MJ2039RX | PCBA Cheat Sensor Receiver |
| GF2010 | +12VDC power supply |
| WN2010 | +5VDC power supply |
| GF2039X | Score Sensor |
| GF2040X | Score Sensor |
| GF2041X | Score Sensor |
| E00724WNBX | ASY (54 RGB LED Tape Strip) |
| E00788GFAX | ASY (White LRG 57 LED Tape Strip) |
| E007788GFBX | ASY (White LRG 12 LED Tape Strip) |
| E00788GFCX | ASY (White LRG 21 LED Tape Strip) |
| E00788GFDX | ASY (White LRG 27 LED Tape Strip) |
| E00788GFEX | ASY (White LRG 30 LED Tape Strip) |
| E00788GFX | ASY (White LRG 63 LED Tape Strip) |
| E00724CXCX | ASY (RGB 12 LED Tape Strip) |
| E00724GFX | ASY (RGB 69 LED Tape Strip) |
| E020207FL | Fan Filter 120MM |
| E02027BCX | ASY (Fan 12 V DC) |
| E08452 | Switch (SPDT) micro |
| GF1194X | ASY (Motor, w/gearbox, plate, etc..) |
| GF2007X | ASY (Power mod 8 AMP) |

Hardware:

| | |
|---------------|--------------------------------|
| AA6105 | Latch Tool |
| AA5001A8X | ASY Coin Door O/U Black W/Dual |
| AA5001A-P802X | ASY Upper Door Black w/Dual |
| AA5001A-P802 | UPPER Door Blank Black w/Dual |
| HD1052 | Caster (3 swivel) |
| HH5005 | Ticket Dispenser (Entropy) |
| MA3006 | T-molding 25/32 Yellow) |

Misc:

| | |
|---------|---|
| CG2027 | Power Cord |
| GF3001X | Fishbowl assembly (w insert & Lubed o-ring) |
| GF3024X | Ping Pong Balls (36 per bag) |
| GF4001X | O-ring with lube |



WARRANTY POLICY

I.C.E. INC warrants all components in new machines to be free of defects in materials and workmanship for the period listed below:

- 180 days on Main PCB's, Computers & Motors
- 1 year on all LCD monitor panels
- 90 days on all other electronic and mechanical components
- 30 days on all I.C.E. repairs and parts purchases

I.C.E. Inc shall not be obligated to furnish a warranty request under the following conditions:

- Equipment or parts have failed through normal wear and tear
- Equipment has been subjected to unwarranted stress, abuse or neglect
- Equipment has been damaged as a result of arbitrary repair/modification

Products will only be covered under warranty by obtaining an I.C.E. authorized RMA #. To obtain an RMA # please provide I.C.E. tech support with the game serial # or original I.C.E. invoice # and a detailed description of the failure or fault symptoms.

I.C.E. Inc. will assume no liability whatsoever for costs associated with labor or travel time to replace defective parts. All defective warranty covered components will be replaced with new or factory refurbished components equal to OEM specifications.

I.C.E. Inc. will cover domestic UPS ground, or comparable shipping costs during the warranty period. International or expedited shipments are available for an additional charge. To obtain credit defective parts must be returned to I.C.E. Inc, at the customer's expense, within 30 days. After 30 days a 15% re-stocking fee will apply to all returns.

ICE distributors are independent, privately owned and operated. In their judgment, they may sell parts and/or accessories other than those manufactured by I.C.E. Inc. We cannot be responsible for the quality, suitability or safety of any non-I.C.E. part or modification (including labor) that is performed by such a distributor.