



Pop the Lock

Licensed By:
Simple Machine

Simple Machine and its logo and Pop The Lock are trademarks of Simple Machine and are used with permission.
© Simple Machine. All Rights Reserved.



FACTORY CONTACT INFORMATION



BAY TEK GAMES INC.
Pulaski Industrial Park
1077 East. Glenbrook Drive
Pulaski, WI 54162 USA

JOIN OUR SERVICE FIRST NETWORK!

This free service is intended to keep you up to date on the latest game information, early notification of parts specials, pertinent technical bulletins, updates on retro fit parts, software upgrades, and much more.

Log on to: www.baytekgames.com/parts
then click on the Parts N' Service tab, or scan the QR code below with your Smartphone to jump straight to this game's parts page!



SALES

P: 920.822.3951

F: 920.822.8936

E: sales@baytekgames.com

PARTS

P: 920.822.3951 X 1101

F: 920.822.1496

E: parts@baytekgames.com

SERVICE

P: 920.822.3951 X 1102

F: 920.822.1496

E: service@baytekgames.com

MON - FRI
8 AM - 5 PM C.S.T.

All games are proudly manufactured at our factory in Pulaski, Wisconsin, USA

TABLE OF CONTENTS

FACTORY CONTACT INFORMATION	2
WELCOME TO: Pop The Lock	4
HOW TO PLAY	5
SPECIFICATIONS	6
SAFETY PRECAUTIONS	6
SETUP GUIDE WITH HASP	7-11
HEIGHT MODIFICATION OPTIONS	12
HOW TO: ACCESS MONITOR	13
DIP SWITCH SETTINGS	14
MAIN MENU FUNCTIONS	15
VOLUME & ATTRACT SETTINGS	16
GAME SETTINGS	17-19
PAYOUT SETTINGS	19
TICKET PATTERNS	20
STATISTICS	21
CIRCUIT BOARD LAYOUT	22
MAINBOARD PINOUT	23
PINOUT GUIDE	24
TROUBLESHOOTING	25-29
WIRING DIAGRAMS	30-34
POWER SUPPLY DIAGNOSTICS	35
DBA DIAGNOSTICS	36
PARTS LIST	37
PARTS PICTURES	38
DECALS DIAGRAM	39
TECHNICAL SUPPORT	40

WELCOME TO: Pop The Lock

Congratulations on your Pop The Lock purchase!

With it's challenging skill-based game play that leaves players wanting to continue their play, Pop the Lock will have you unlocking new profits and fun!

Please take a moment to read through this manual and be sure to contact our factory if you have any questions, or would like some more information.

Thank you for your purchase! Your business is important to us and we hope you enjoy this game as much as we do!

Your Friends at Bay Tek Games



Pop the Lock

GAME INSPECTION

Inspect the game for any damaged, loose, or missing parts.

If damage is found, please contact your freight carrier first.

Then, contact Bay Tek Games' Service Department at 920.822.3951 or e-mail them at service@baytekgames.com for further assistance.

HOW TO PLAY

Press the button to stop the red bar on the yellow dots.



Win tickets for successful hits.

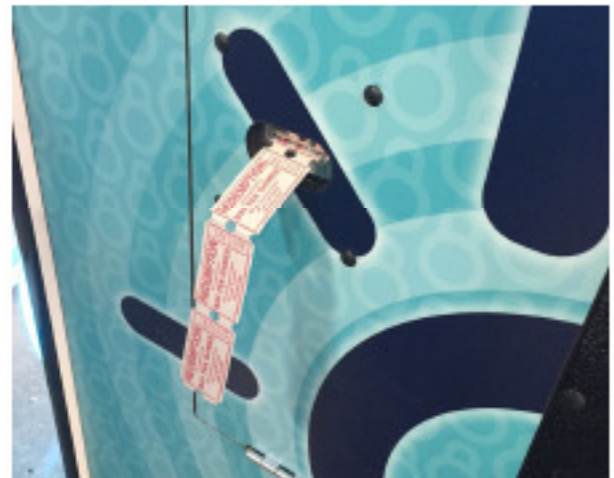

50 in a row wins the jackpot!

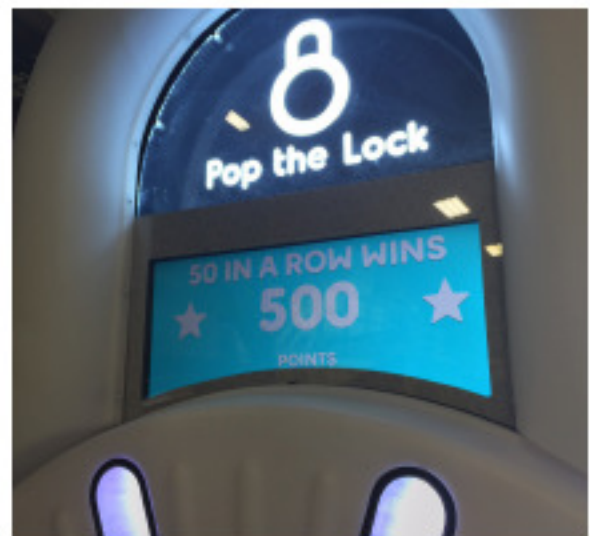

GAME SPECIFICATIONS

WEIGHT	
NET WEIGHT	400 LBS.
SHIP WEIGHT	450 LBS.
DIMENSIONS	
WIDTH	44.5"
DEPTH	44"
HEIGHT	97" (88.75" without 'hasp')
OPERATING TEMPERATURE	
FAHRENHEIT	80-100
CELSIUS	26.7-37.8

POWER REQUIREMENTS			
INPUT VOLTAGE RANGE	100 to 120 VAC	/	220 to 240 VAC
INPUT FREQUENCY RANGE	50 HZ	/	60 HZ

MAX OPERATING CURRENT	
1.4 AMPS @ 115 VAC	
.8 AMPS @ 230 VAC	

SAFETY PRECAUTIONS

NOTICE	
Modifications to the mechanical, electrical and structural components of this game may void its compliance certifications.	
This appliance is suitable for INDOOR, DRY locations only.	
DANGER	
DO NOT perform repairs or maintenance on this game with the power ON. Unplug the unit from the wall outlet or shut off the power strip located inside the cabinet.	
WARNING	
Use of flammable substances can cause sever burns or serious injury. Always use NON-FLAMMABLE solvents for cleaning. DO NOT use gasoline kerosene or thinners.	
CAUTION	
Lifting heavy objects can cause back, neck or other injuries. Be sure adequate lifting and moving devices are available when unloading, unpacking and moving this game.	
ATTENTION	
Be sure the electrical power matches the game requirements. See the serial number located on the back of the game cabinet. Always plug into a grounded circuit. If the supply cord is damaged, it must be replaced by an approved cord or assembly provided by the manufacturer. A shielded power cable must be used for the game to retain EU/EMC compliance.	
IN CASE OF EMERGENCY	
UNPLUG THE POWER CORD. The power cord must be accessible at all times in case of an emergency.	

SETUP GUIDE WITH HASP

⚠ CAUTION ⚠

USE CAUTION WHEN RELEASING THE LATCHES! THE MONITOR FACE IS A FALL HAZARD AND COULD CAUSE DAMAGE! GET ASSISTANCE FROM SOMEONE IF NEEDED.

Remove back door of game and set aside. Release the four latches - two found inside the back of the cabinet on both sides and two on the outside top.

Unhook the S hook and chain from the bracket on the inside, left rear of the cabinet.

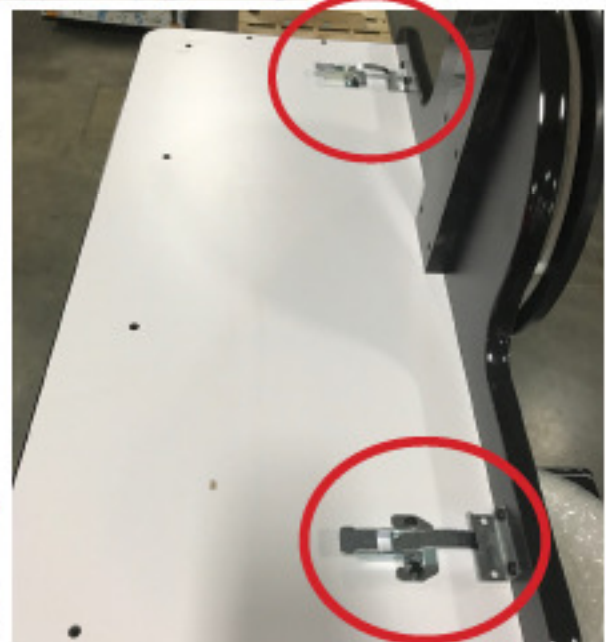
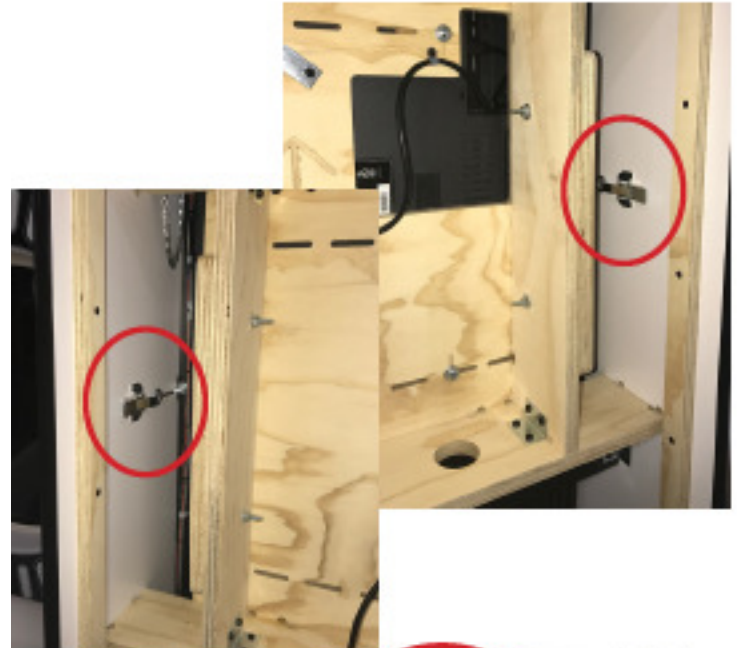

Lower the monitor face/vacuum form carefully.



SETUP GUIDE WITH HASP CONT.

Carefully lift the circular "Pop The Lock" marquee piece on top of the monitor face and slide into place, being careful not to pinch the cable.



Locate the marquee hardware kit in the cashbox.



Secure the marquee piece in place using the 4 screws (circled in blue) and the 2 bolts and 2 washers (circled in pink) from the hardware kit.



SETUP GUIDE WITH HASP CONT.

Route the cable from the circular piece through the channel on the back of the monitor face.



Plug cable CE5931 from the circular marquee piece into cable CE5932.

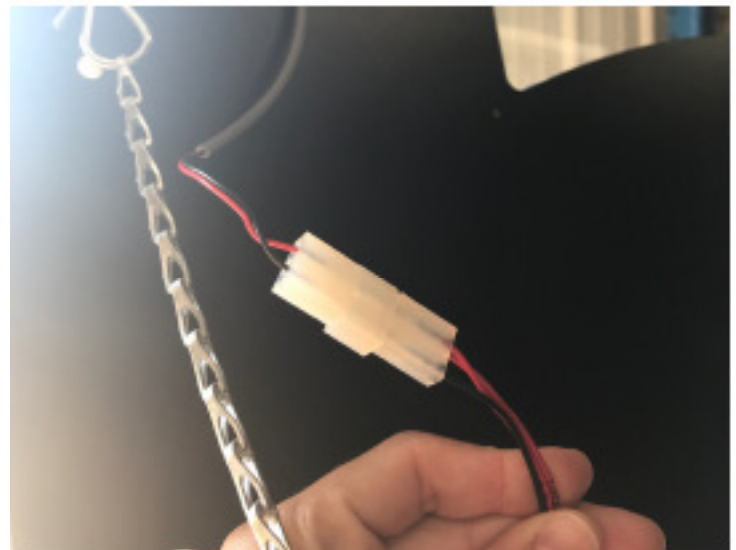

Get assistance from someone and place the hasp piece near it's proper location. Route cable CE 5926-1 from the hasp piece, through the circle cut out in the monitor face.



SETUP GUIDE WITH HASP CONT.

Secure the hasp piece in place using the four included bolts and washers. Tighten in place.



Lift the monitor face/vacuum form up towards the monitor. Route all wires through the rear before pinching them. Rehook the latches in the top rear of the cabinet to secure the face in place.



Plug the top marquee light cable (CE5931) into CE5932.



SETUP GUIDE WITH HASP CONT.

Plug in cable CE5903 to cable CE5926-1.

Plug in cable CE5930-1 to cable CE5901.

Plug in cable 5918 to the small circuit board on the side of the cabinet and the single red wire from CE5932.

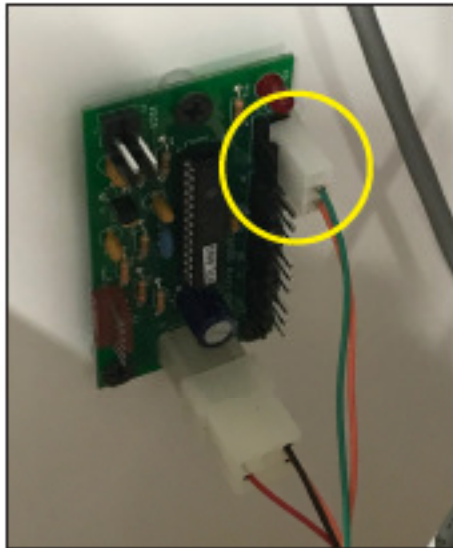

Replace the back door and lock. Place game in desired location. Plug the power cord into a standard electrical outlet and turn the power strip inside the front door to ON.



HEIGHT MODIFICATION OPTIONS

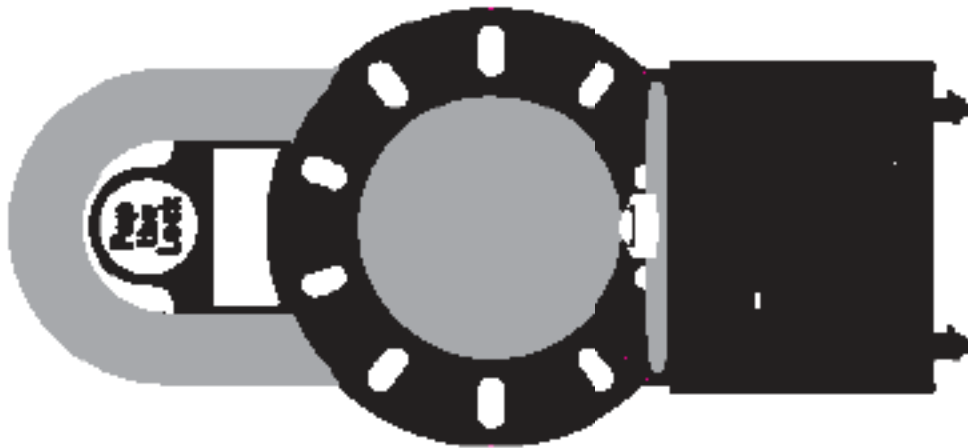

88.32"

(Full height or less)

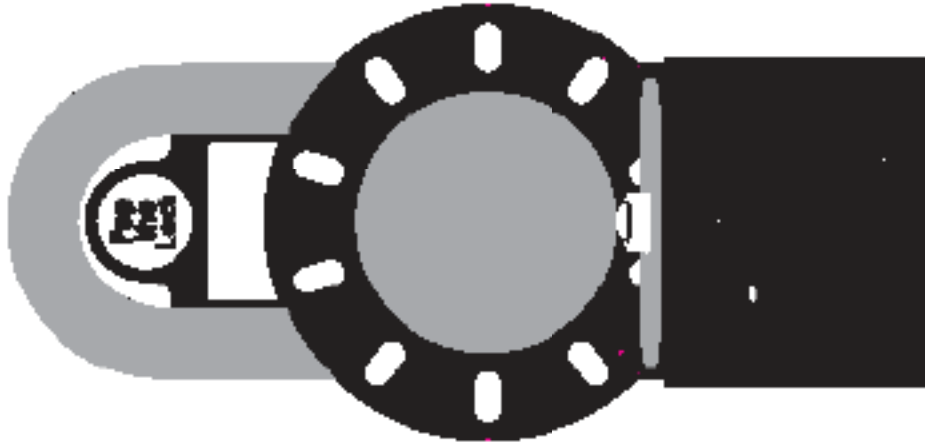

84.08"

(Seaters removed)

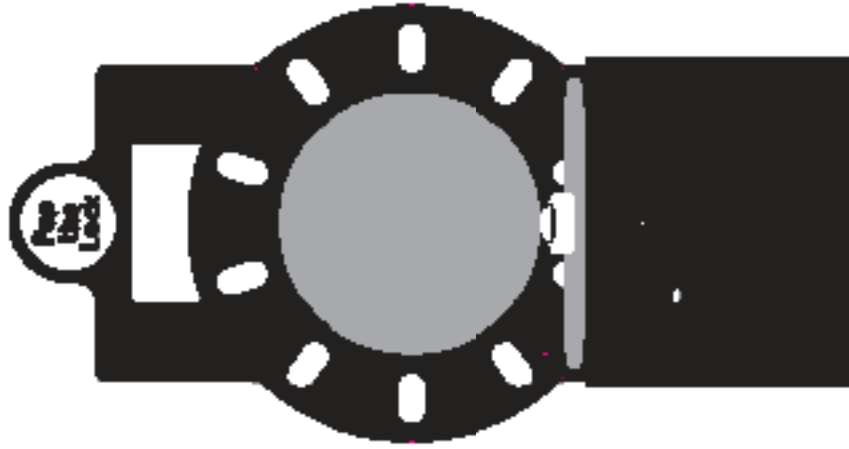

86"

(Minimum gross height)



SUMMITTED MEMBER
 For maximum height of seat, call your Service Department. For a number of seat set in installation to measure the height.

© BAYTEK, INC.



HOW TO: ACCESS MONITOR

Remove back door of cabinet and set off to the side.



Unplug cables CE5919 and CE5930 from the circuit board located to the left rear in the back of the cabinet.



Release the four latches - two found inside the back of the cabinet on both sides and two on the outside top.



Unhook the S hook and chain from the bracket on the inside, left rear of the cabinet.

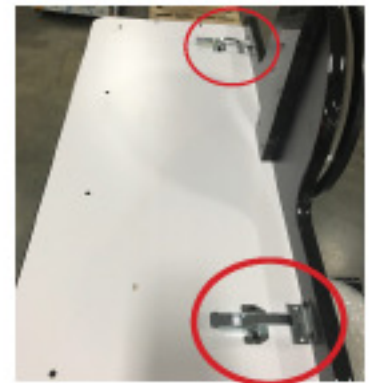

CAUTION

USE CAUTION WHEN RELEASING THE LATCHES! THE MONITOR FACE IS A FALL HAZARD AND COULD CAUSE DAMAGE! GET ASSISTANCE FROM SOMEONE IF NEEDED.

The front of the cabinet will release. You may carefully lower the vacuum form and expose the monitor face.



DIP SWITCH SETTINGS

The dip switch bank is located on the mainboard, inside the front door of the game.

*factory default settings are highlighted below



SWITCH	DESCRIPTION	ON	OFF
1			X
2	New Jersey Programming		X
3			X
4			X

MAIN MENU FUNCTIONS

Press and hold the MENU button located inside the front door to access the Main Menu.

Scroll through the options with the MENU button.

Make your selections with the MENU SELECT button.

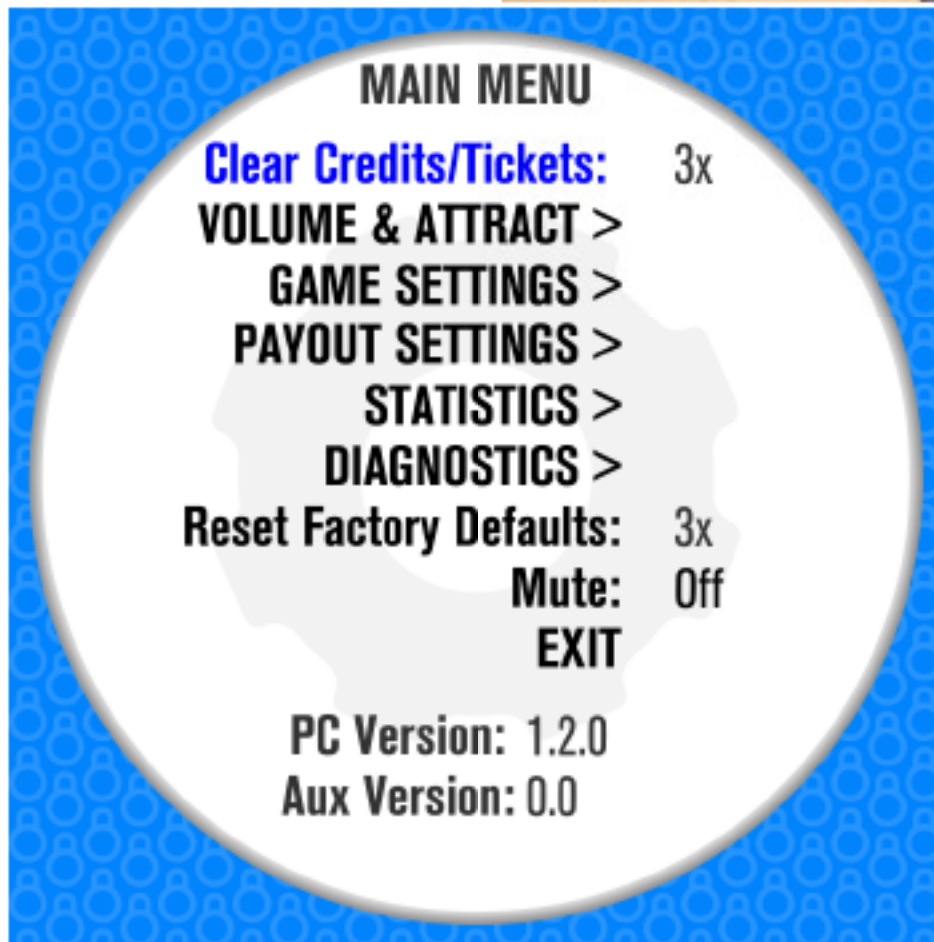
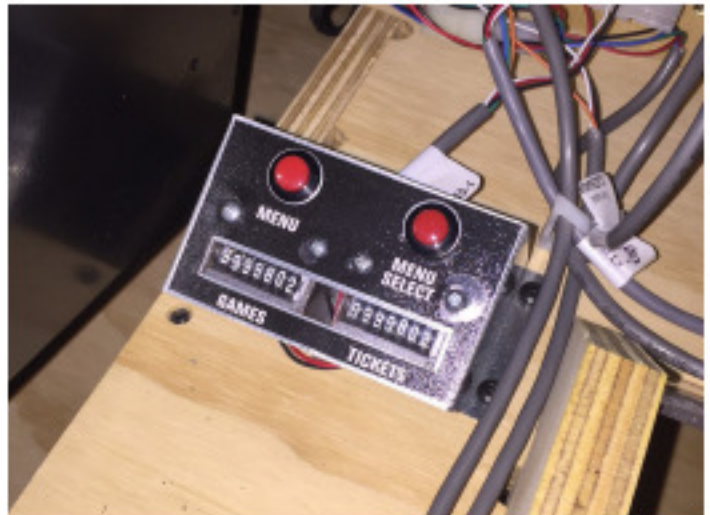

Factory defaults are highlighted below.

MAIN MENU OPTIONS			
CLEAR CREDITS/ TICKETS	Press the MENU SELECT button 3 times to clear tickets and credits owed		
RESET FACTORY DEFAULTS	Press MENU SELECT button 3 times to reset all settings to factory defaults		
MUTE	<table border="1" style="width: 100%; text-align: center;"> <tr> <td>ON</td> <td style="background-color: yellow;">OFF</td> </tr> </table>	ON	OFF
ON	OFF		

VOLUME & ATTRACT SETTINGS MENU

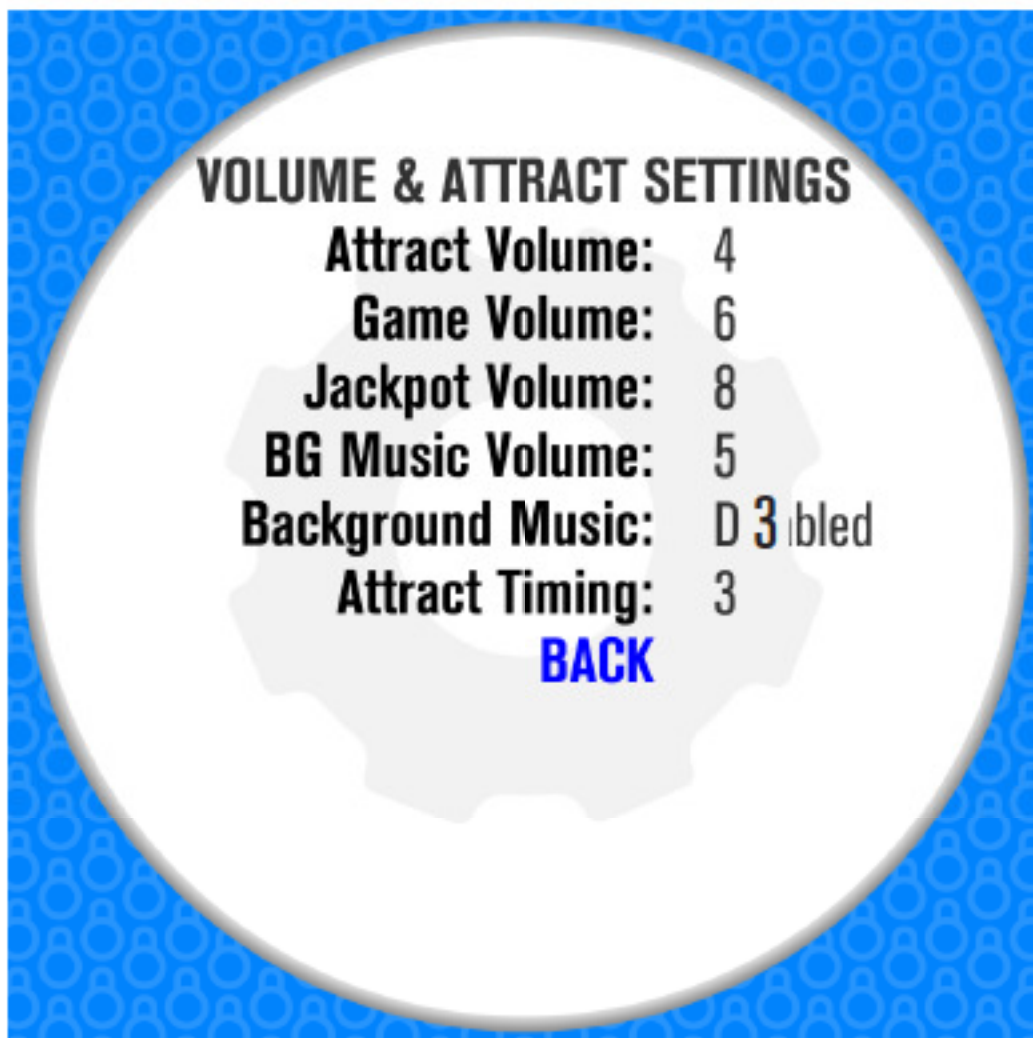

Factory defaults are highlighted below.

VOLUME & ATTRACT OPTIONS											
ATTRACT VOLUME	0	1	2	3	4	5	6	7	8	9	10
GAME VOLUME	0	1	2	3	4	5	6	7	8	9	10
JACKPOT VOLUME	0	1	2	3	4	5	6	7	8	9	10
ATTRACT TIMING (MINUTES)	0 (OFF)	1	2	3	4	5	6	7	8	9	10
BG MUSIC VOLUME	0	1	2	3	4	5	6	7	8	9	10
BACKGROUND MUSIC	ENABLED							DISABLED			

GAME SETTINGS MENU

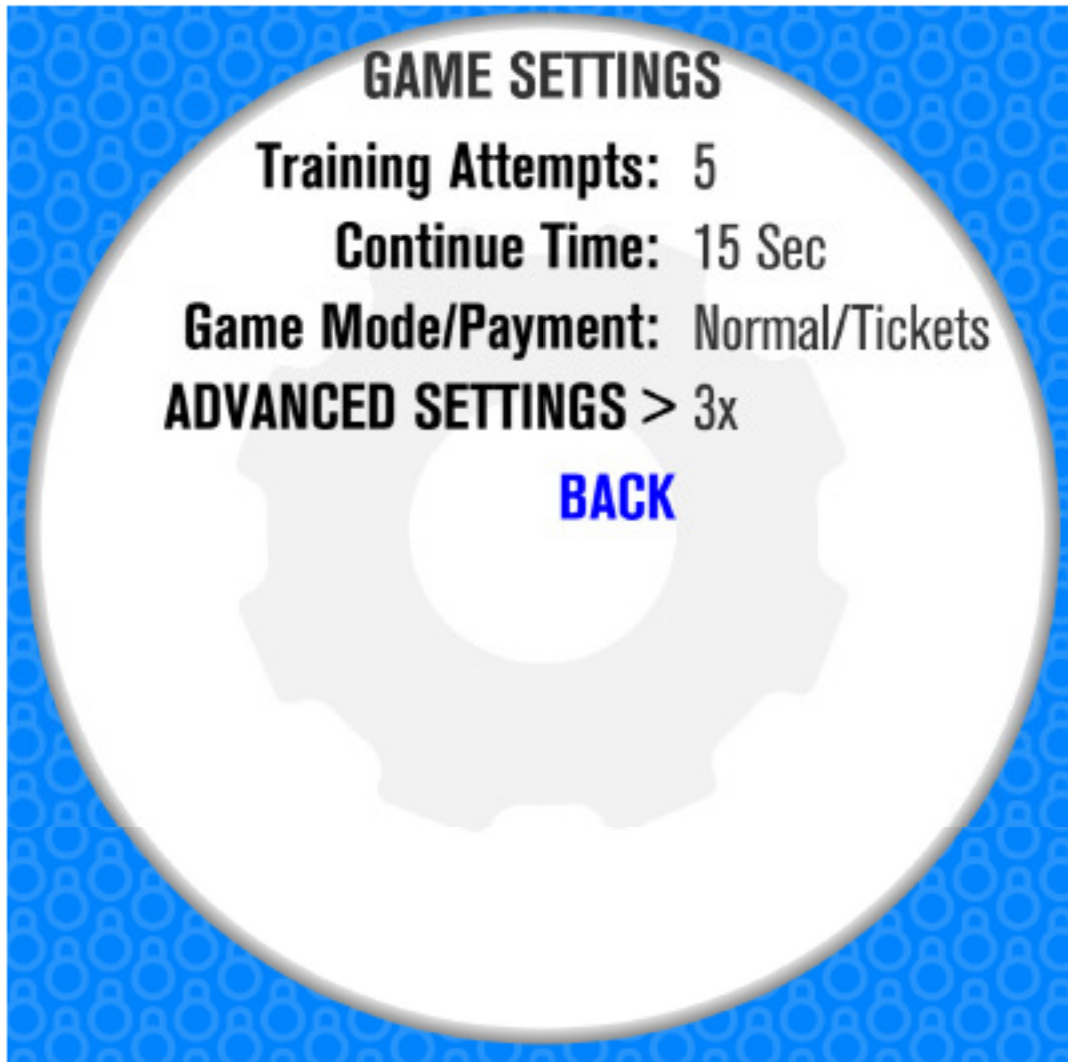

Factory defaults are highlighted below.

GAME SETTINGS OPTIONS						
TRAINING ATTEMPTS Number of times game allows for player to continue playing until a successful hit is made	0	1	2	3	4	5
CONTINUE TIME Amount of seconds allowed for a player to insert credits & continue play	5s	10s	15s	20s	25s	30s
GAME MODE/PAYMENT	NORMAL/TICKETS		ENTERTAINMENT ONLY/POINTS		DEMO	
ADVANCED SETTINGS	Push MENU SELECT button 3 times to be taken into the sub-menu of advanced settings (found on page 16 of the manual)					

ADVANCED SETTINGS MENU

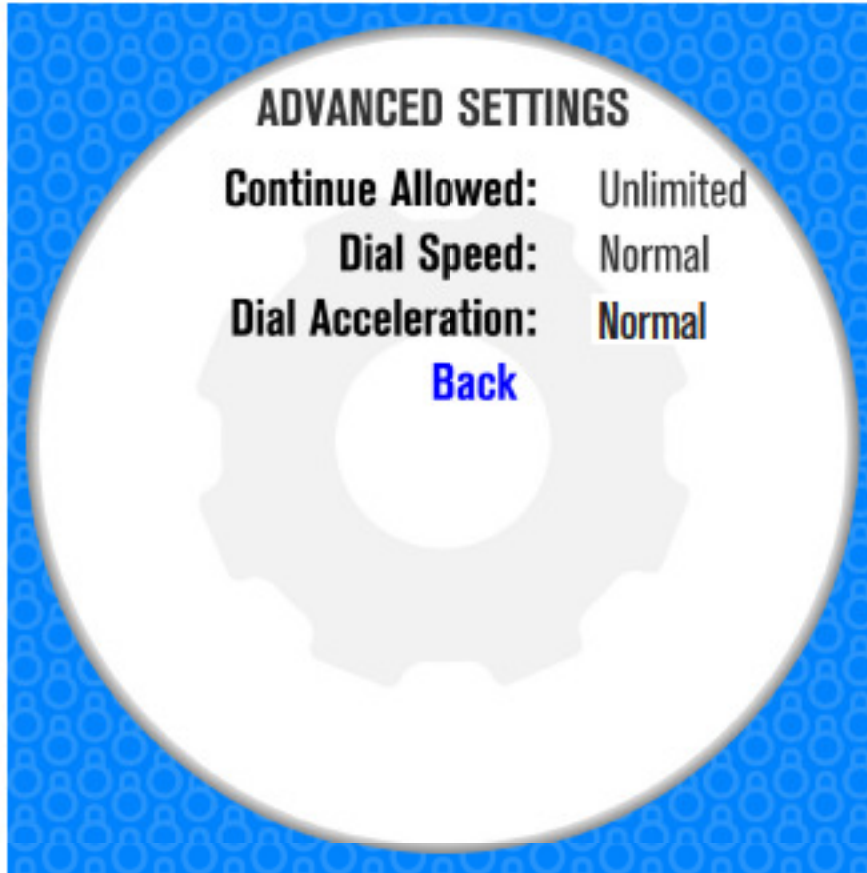

Factory defaults are highlighted below.

GAME SETTINGS OPTIONS					
CONTINUES ALLOWED Number of times game allows for player to continue playing same game	UNLIMITED	0 (disabled)	TO (INC 1)	5	
DIAL SPEED Adjusts overall game difficulty - making the dial rotate slower or quicker	EASIEST	EASY	NORMAL	HARD	HARDEST
DIAL ACCELERATION The rate of speed increase on the last 10 of the 50 hits	EASIEST	EASY	NORMAL	HARD	HARDEST

PAYOUT SETTINGS MENU

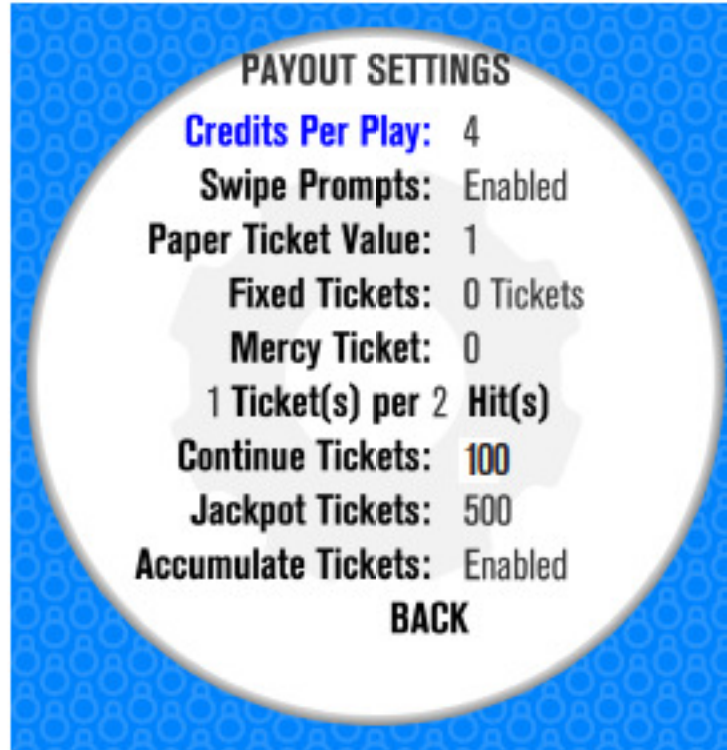

Factory defaults are highlighted below.

PAYOUT MENU OPTIONS										
CREDITS PER PLAY	FREE PLAY		TO (INC 1)		20			DEFAULT: 4		
SWIPE PROMPT/CARD READER <small>Changes "Credits 0/4" to "Swipe Card"</small>	ENABLED					DISABLED				
PAPER TICKET VALUE	1					2				
FIXED TICKETS	0		TO (INC 1)		30			DEFAULT: 0		
MERCY TICKETS	0	1	2	3	4	5				
TICKETS AWARDED FOR AMOUNT OF HITS SET BELOW	1			2			3			
NUMBER OF HITS TO WIN ABOVE SELECTED AMOUNT OF TICKETS	1	2	3	4	5	6	7	8	9	10
CONTINUE TICKETS	5		TO (INC 5)		500			DEFAULT: 100		
JACKPOT TICKETS	50		TO (INC 50)		2000			DEFAULT: 500		
ACCUMULATE TICKETS <small>All tickets earned from hitting the dots during play will be added to the jackpot/continue value.</small>	ENABLED					DISABLED				

TICKET PATTERNS

TICKET PATTERNS			
AVG. TIX PER GAME	TIX/HIT	CONTINUE BONUS AMOUNT	JACKPOT BONUS AMOUNT
3	1/10	20*	50
9	1/3	20	100
18	1/4	50	250
20	1/3	50	250
25	1/2	50	250
33	1/3	100	500
37	2/4	100	500
45	1/3	150	750
50	2/4	150	750
58	1/3	200	1000
62	2/4	200	1000
74	1/1	200	1000

*ADJUST TO ONLY 1 CONTINUE ALLOWED IN 'ADVANCED SETTINGS'

STATISTICS

STATISTICS

Total Games Played: 0

Total Tickets: 0

Total Continues: 0

Continue Winners: 0

Jackpot Winners: 0

Average Tickets: 0

Jackpot Tickets: 0

Second Chance Tickets: 0

Normal Tickets: 0

Reset Statistics: cleared

BACK

STATISTICS	
Total Games Played	Number of games played since last reset
Total Tickets	Number of tickets payed out since last reset
Total Continues	Number of times players selected the 'continue game' option
Continue Winners	The number of games won on "continue game" option
Jackpot Winners	Number of times Jackpot has been won
Average Tickets	Average number of tickets paid out per play
Jackpot Tickets	Total number of tickets paid out on Jackpot wins
Second Chance Tickets	Total number of tickets paid out on "continue game" plays
Normal Tickets	Total number of tickets paid out on regular game plays
Reset Statistics	Press MENU SELECT button 3 times to clear stats

CIRCUIT BOARD LAYOUT

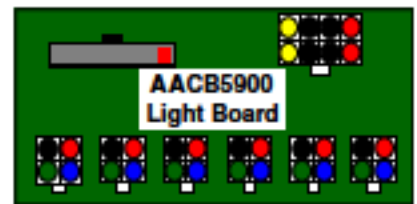
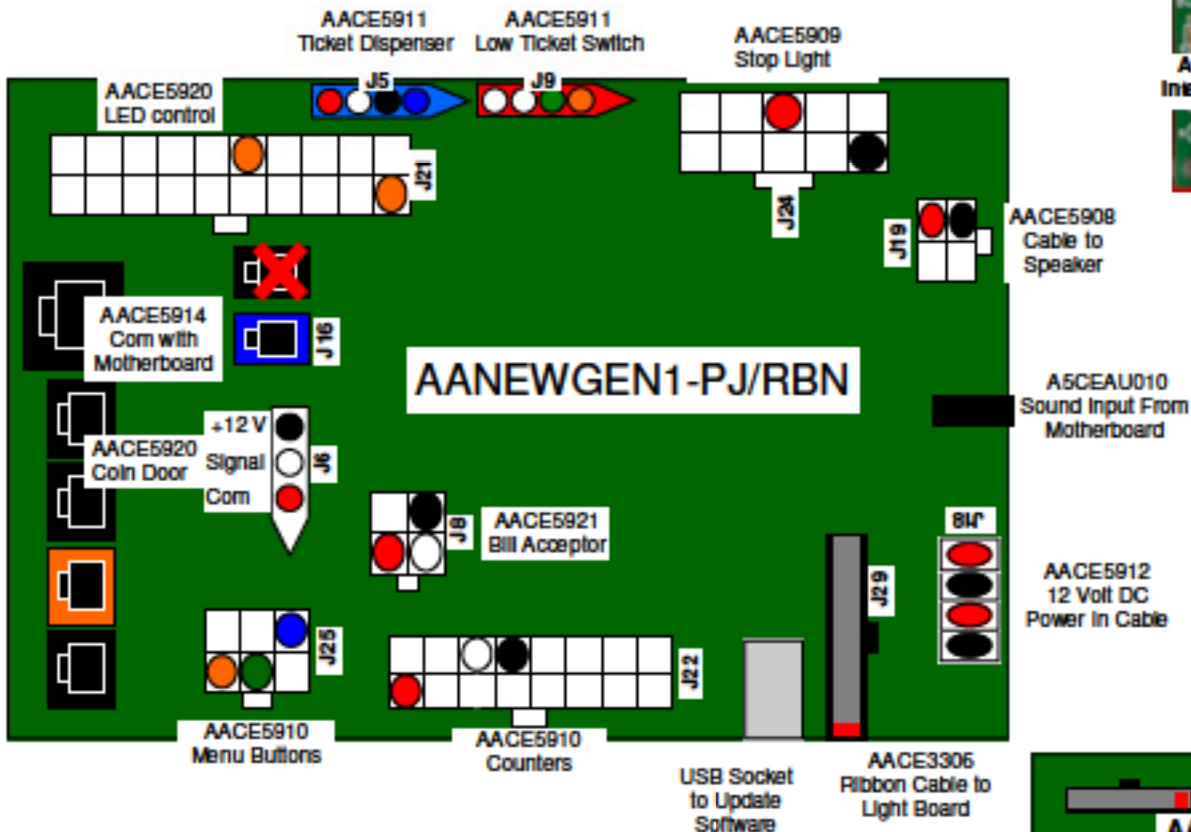
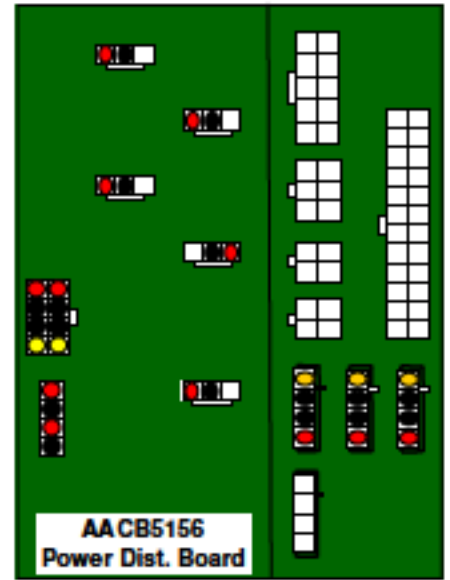
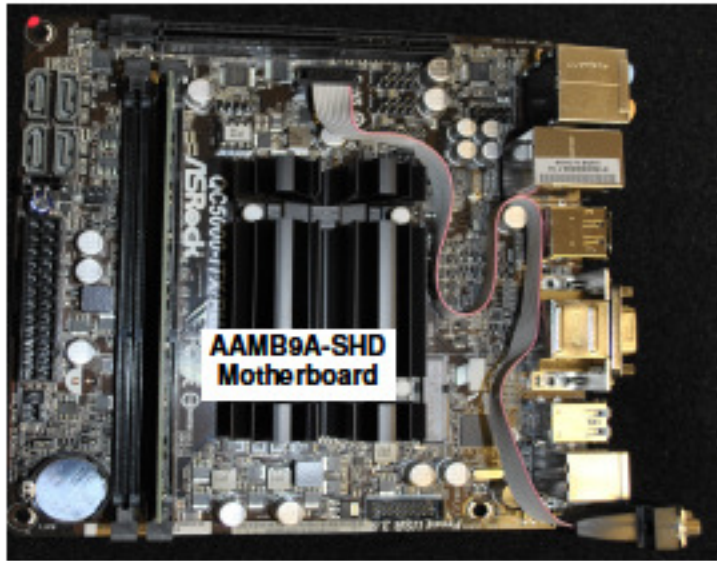

MAINBOARD PINOUT

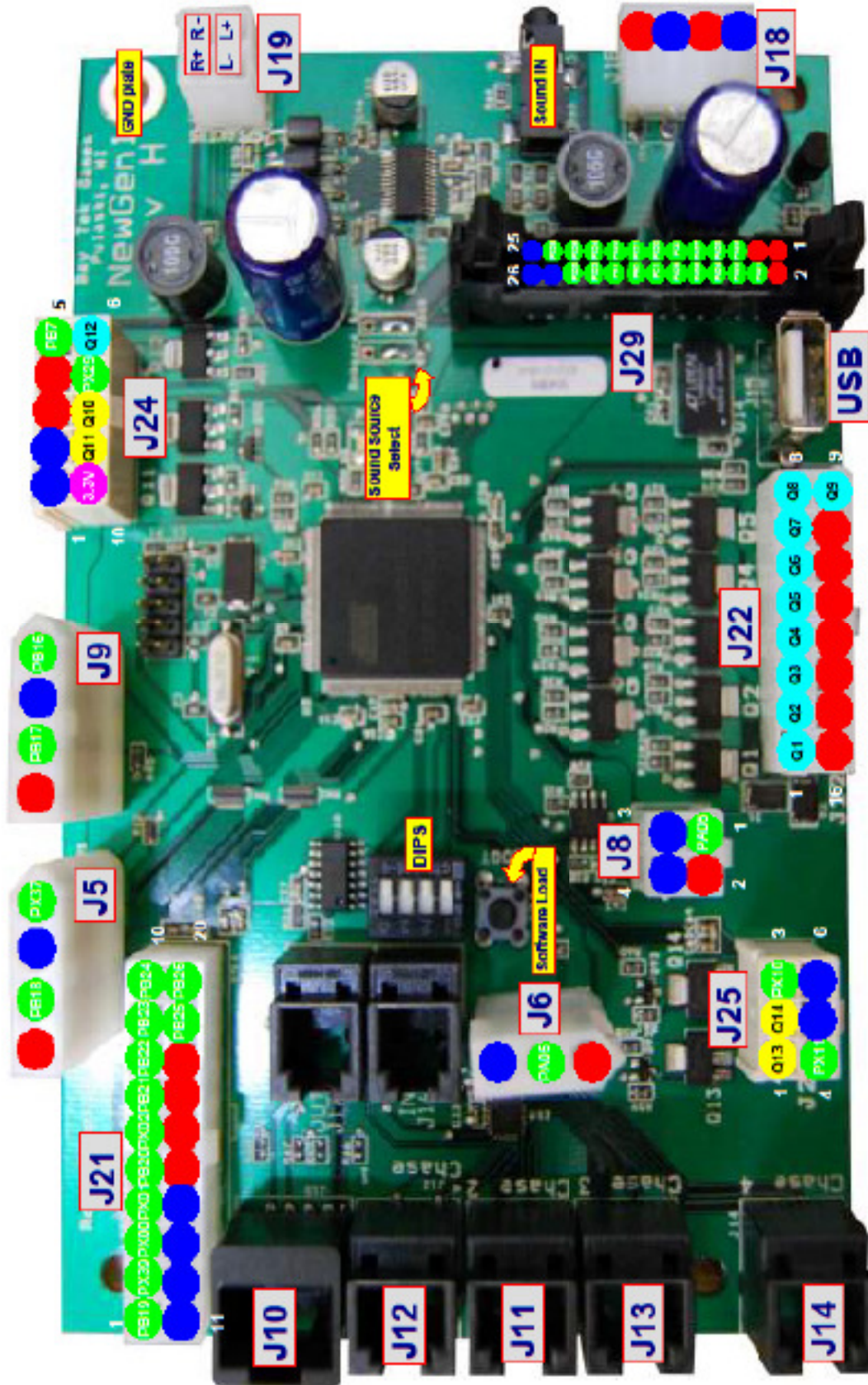

- SPI Out - Display - (J10)**
 - Pin 1 & Pin 3 - +12V
 - Pin 2 - SCLK_BUS2
 - Pin 4 - SMOSI_BUS2
 - Pin 5 & Pin 7 - Ground
 - Pin 6 - SCS2_BUS2
 - Pin 8 - SMISO_BUS2
- Chase Lights (J11, J12, J13, J14)**
 - Pin 1 - Chase Output
 - Pin 2 - Chase Output
 - Pin 3 - +12V
 - Pin 4 - Chase Output
 - Pin 5 - Chase Output
 - Pin 6 - +12V

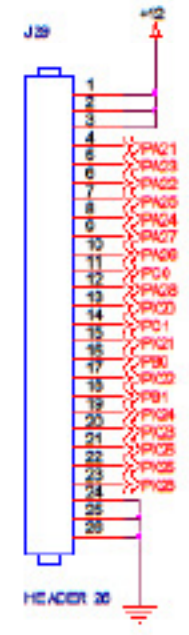

- Ground
- +12V
- Low Side Driver
- High Side Driver
- TTL Logic
- +3.3V

MAINBOARD PINOUT GUIDE

Pin Type	Purpose	Ref	Pin #	Pin Type	Purpose	Ref	Pin #
LOWSIDE #1, w diode	Game Counter Ticket Counter	J22	1	Ground	Play Button Play Button Light	J24	1
LOWSIDE #2, w diode		J22	2	Ground		J24	2
LOWSIDE #3		J22	3	+12 Volts		J24	3
LOWSIDE #4		J22	4	+12 Volts		J24	4
LOWSIDE #5		J22	5	PB7		J24	5
LOWSIDE #6		J22	6	LOWSIDE #12		J24	6
LOWSIDE #7		J22	7	PX29		J24	7
LOWSIDE #8		J22	8	HIGHSIDE #10		J24	8
LOWSIDE #9		J22	9	HIGHSIDE #11		J24	9
+12 Volts	J22	11	3.3V	J24		10	
+12 Volts	J22	12	PX37	Ticket Notch #1	J5	1	
+12 Volts	J22	13	Ground	Ground for Ticket Disp	J5	2	
+12 Volts	J22	14	PB18	Ticket Motor #1	J5	3	
+12 Volts	J22	15	+12 Volts	Power for Ticket Disp	J5	4	
+12 Volts	J22	16					
HIGHSIDE #13	J25	1	PB18	Low Ticket Input	J9	1	
HIGHSIDE #14	J25	2	Ground		J9	2	
PX10	Service Button #1	J25	3	PB17		J9	3
PX11	Service Button #2	J25	4	+12 Volts		J9	4
Ground	Ground for Buttons	J25	5				
Ground		J25	6				
+12 Volts	Coin Door Power	J8	1	PA08	DBA Input	J8	1
PA05	Coin Input	J8	2	+12 Volts		J8	2
Ground	Coin Ground	J8	3	Ground		J8	3
				Ground		J8	4
PB19	NJ Lockout	J21	1	+12 Volts		J29	1
PX39		J21	2	+12 Volts		J29	2
PX00		J21	3	+12 Volts		J29	3
PX01		J21	4	PA21	Sides R	J29	4
PB20		J21	5	PA23	Sides G	J29	5
PX02		J21	6	PA22	Sides B	J29	6
PB21		J21	7	PA25	Marquee R	J29	7
PB22		J21	8	PA24	Marquee G	J29	8
PB23		J21	9	PA27	Marquee B	J29	9
PB24		J21	10	PA26	Playfield R	J29	10
Ground		J21	11	PA28	Playfield G	J29	11
Ground		J21	12	PC0	Playfield B	J29	12
Ground		J21	13	PX20	Console R	J29	13
Ground		J21	14	PC1	Console G	J29	14
+12 Volts		J21	15	PX21	Console B	J29	15
+12 Volts		J21	16	PB0	Button R	J29	16
+12 Volts		J21	17	PX22	Button G	J29	17
+12 Volts		J21	18	PB1	Button B	J29	18
PB25		J21	19	PX24		J29	19
PB26		J21	20	PX23		J29	20
			PX26		J29	21	
			PX25		J29	22	
			PX28		J29	23	
			Ground		J29	24	
			Ground		J29	25	
			Ground		J29	26	

Low Side Driver
High Side Driver
TTL Input/Output
LED Constant Current Drive
12 Volts
Ground

To Light Control Board



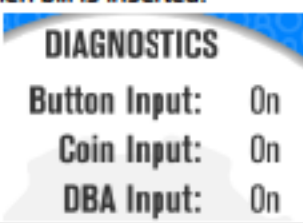

TROUBLESHOOTING GUIDE

Troubleshooting Strategy

Use common sense and a systematic method of troubleshooting to determine the exact problem, probable cause and remedy. Use the process of elimination to find the faulty component. Always check for the simple and obvious causes first such as unplugged, loose or broken wires and bad sensors, bent, pinched, stuck or jammed components.

Troubleshooting Chart		
Problem	Probable Cause	Remedy
<p>No power to the game. No lights on at all.</p>	<p>Unplugged. Circuit breaker tripped. Line Filter Faulty. Power strip faulty. Faulty cable/power supply</p>	<p>Check wall outlet. Reset power strip breaker switch or building circuit breaker. Replace Line Filter (Part # A5FI9010) Change plug position, replace if needed. See Power Supply diagnostic below.</p>
<p>Bill Acceptor and monitor on. But everything else off. (Power Supply not ON)</p>	<p>Power supply unplugged. Rocker Switch. Power supply shutting down because of 12 V overload. Faulty power supply. Faulty Power Dist Board</p>	<p>Insure unit is plugged into power strip. Make sure rocker switch is set ON. See power supply diagnostics to isolate bad component. A bad motor or 12 volt short would cause this. See Power Supply Diagnostic below. Replace Power Distribution Board (AACB5156)</p> 
<p>Dollar Bill Acceptor not functioning. Ensure Bill Acceptor is set to "Always Enable" Important : Only 110 Volt AC DBA is to be installed. Enter Diagnostic Menu to see if DBA input flashes ON quickly when bill is inserted.</p> 	<p>Look for "Check Newgen Comm" error on screen. Check for power to Bill Acceptor. Dirt or debris in acceptor slot. Pinched, broken, or disconnected wiring. Bill acceptor problem. Part # A5AC9091</p>	<p>Refer to "Check Newgen Comm" error diagnostic section. Acceptor should cycle stacker at game power up. If not, check cable connections. Refer to "How to Clean Bill Acceptor" Or clean with bill reader cleaning card. (A5CC9000) Check wiring from bill acceptor to Mini Gen Board. (AACE5921) Repair or replace wiring harness. Check J8 connector on Main Board Make sure wires are secure in connectors. Refer to troubleshooting section of dollar bill acceptor manual included with this game or the diagnostics label of the back of the unit.</p>
<p>Meters does not work. Game meter will click at the end of the game. Ticket meter will click as tickets come out of game and notch is "seen" by dispenser.</p>	<p>Ensure correct number of tickets are being dispensed Disconnected, loose or broken wires. Faulty counter.</p>	<p>Check ticket values in menu. Test Ticket Dispense in Diagnostic menu. Refer to Tickets not dispensing troubleshooting section. Check connections and reseal J25 on Newgen board. Cables # AACE5910 and AACO1000 Replace counter. AACO1000.</p>

TROUBLESHOOTING GUIDE

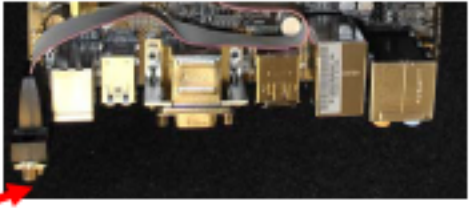
Problem	Probable Cause	Remedy
<p>Game not coining up. Enter Diagnostic Menu to see if Coin input goes to ON quickly when coin is inserted.</p> <p>DIAGNOSTICS</p> <p>Button Input: On Coin Input: On DBA Input: On</p>	<p>Look for "Check Newgen Comm" error on screen.</p> <p>Ensure game makes sound when coin switch is triggered.</p> <p>Game set to large amount of credits per game.</p> <p>If Coin Input stays ON</p>	<p>Refer to "Check Newgen Comm" error diagnostic section.</p> <p>Check coin switches—both should be wired normally open. If one switch is "closed" the other will not work either. Check wiring to Mini Gen Board. (AACBL4A-DOOR, AACE5920)</p> <p>Check Game Setup Menu. Ensure Coins/Credits per Game is set. Default = 4.</p> <p>Replace faulty Newgen Board. AANEWGEN1-PJ/RBN</p>
<p>No Sound</p> <p>Motherboard creates sound, AANEWGEN1-PJ/RBN board amplifies it.</p>   <p>ASCEAU010 Audio Jack from Motherboard to Newgen Board</p>	<p>Volume set to zero in menu.</p> <p>Disconnected, loose or broken wires.</p> <p>Determine if Newgen board is good.</p> <p>Faulty speaker.</p>	<p>Enter Volume & Attract Settings Menu and verify: Game Volume & Attract Volume is not zero</p> <p>Check connections and reseat audio cable from motherboard to Newgen board. Cables # AACE8811, AACE5908, and A5CEAU010.</p> <p>Unplug audio jack cable (A5CEAU010) from motherboard, plug into MP3 player and see if music is amplified and comes out of speaker. If Yes - then motherboard is faulty. If No - then Newgen may be faulty.</p> <p>Replace speaker. AACE8811</p>
<p>Check Newgen Comm Error</p> <p>Game does not coin up but credit meter clicks.</p>	<p>Main Board and wiring to coin switch OK.</p> <p>Check green LED's on Serial Interface board. Is "Power" solid ON?</p> <p>CHECK MINIGEN COMM! Is "TX" & "RX" blinking very fast?</p> <p>If "Power" is not solid ON Ensure AACE5914 cable is plugged into blue "IN" socket on main board. (J16) Replace if needed. Replace Serial Interface board. (A5CB2204A)</p> 	 <p>If "TX" & "RX" are not blinking very fast Communication to Motherboard faulty.</p> <p>Check AACE5913 to motherboard. Check or replace adaptor (A5CN1031)</p> 



TROUBLESHOOTING GUIDE

Problem	Probable Cause	Remedy
LED white lower cabinet lighting not working.	LED's to light up playfield receive 12 Volts DC from power supply through the Power Distribution Board.	Check for proper connection from power supply to Power Distribution Board and then to LED strips. Check continuity. (AACE5936, AACE5936, AACE5934, AAPS1013-PTL) Refer to "AC In, Power Supply Wiring Diagram section"
Colored cabinet lighting not working.	If all colored cabinet lights are not functioning, check Light Board (AACB5900) If LED strip is out, check cable. Refer to "Light Board Wiring Diagram" Faulty LED Faulty Minigen Board	Check power to Light Board from Power Distribution Board. Cable # AACE5915. Check ribbon cable to Light Board from Newgen Board. Cable # AACE5933 Check for proper connection from Light board to LED strips. Check continuity. Refer to "Light Board Wiring Diagram" Swap LED connector from one socket to the other to verify. Replace LED (AACE8622) Replace Minigen board. (AANEWGEN1-PJ/RBN)
White LED's around monitor do not work.	Faulty Cable Faulty LED	Check for proper connection from Light board to LED strips. Check continuity. (AACE5930, AACE5901) Swap LED connector on Light Board to verify. Replace LED if needed. (AACE5930)
Colored LED's around monitor do not work.	Faulty Cable Faulty LED Faulty Chase Board	Check for proper connection from Chase Board to LED strips. Check continuity. (AACB5935, A5CB5901, AACE5918) Refer to "Coin Mech, Menu & Counter Wiring Diagram" There are 10 LED blocks in series that surround the monitor. If one LED block is faulty, the following LED blocks will not work. Red Led on board only blinks at power on. Verify 12 volts to board from Power Distribution Board. Check cable AACE5920 Replace Chase board if needed. (AA9503-PTL)
Marquee Lights are not on.	Faulty Cable Faulty LED	Check for proper connection from Power Distribution board to LED strips. Check continuity. (AACE5931, AACE5932) Replace LED (AACE5931)
Menu Buttons do not work.	Swap connectors at the 2 buttons. Pinched, broken, or disconnected wiring Main board faulty.	Replace button if problem stays with button.(AAPB2700) Inspect crimp to ensure good connection. Check connections from menu buttons to main board. Check continuity on wires. (AAPB2700, AACE5910) Replace Newgen Board. (AANEWGEN1-PJ/RBN)

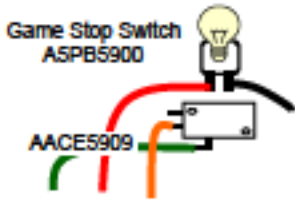
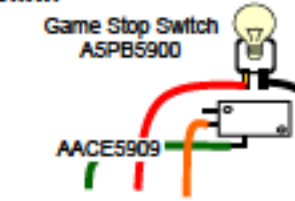
TROUBLESHOOTING GUIDE

<p>Tickets do not dispense or Wrong amount dispensed.</p> <p>Check for the correct amount of tickets showing on Monitor</p>	<p>Tickets on monitor does not match tickets coming out of game.</p>	<p>Opto Sensor on ticket dispenser dirty.</p> <p>Faulty ticket dispenser.</p> <p>Notch on tickets cut too shallow.</p> <p>Faulty cable. Disconnected, loose or broken wires.</p> <p>Enter Diagnostic menu and test Dispenser</p> <p>Faulty Main Board.</p>	<p>Blow dust from sensor and clean with isopropyl alcohol.</p> <p>Replace with working dispenser to isolate the problem. (A5TD1)</p> <p>Flip tickets and load upside-down to have large cut notch toward opto sensor.</p> <p>Check connectors from ticket dispensers to Newgen board. Check for continuity. Cables AACE5911</p> <p style="text-align: center;">Test Ticket Dispense:</p> <p style="text-align: center; color: blue;">Back</p> <p>Replace Newgen board(AANEWGEN1-PJ/RBN)</p>
	<p>Tickets on monitor does match tickets coming out of game.</p>	<p>Settings in Menu are incorrect.</p>	<p>Enter Menu and check certain areas: Paper ticket ratio Mercy tickets Preset Payout Pattern Fixed tickets Tickets per payout hit Tickets earned every X hits</p>
<p>Low Tickets message on monitor</p>	<p>Tickets are empty in ticket tray</p> <p>Faulty cable. Disconnected, loose or broken wires.</p> <p>Faulty low ticket switch.</p> <p>Faulty Newgen Board</p>	<p>Load tickets into tray. Ensure tickets hold down micro switch wire.</p> <p>Check connectors from low ticket switches to Newgen board. Check for continuity. (AACE5911)</p> <p>Inspect switch and replace if needed. (AASW200)</p> <p>Replace Newgen Board. (AANEWGEN1-PJ/RBN)</p>	
<p>Button does not work</p> 	<p>Button stuck, sticky or broken.</p> <p>Disconnected, loose or broken wires.</p> <p>Enter Diagnostic Menu to see if game recognizes button.</p> <p>Faulty button.</p>	<p>Clean top of button, ensure it springs back when pushed down. Look for broken tab on bottom of switch</p> <p>Check connections from switch to Newgen board. Orange & Green wires (Cable # AACE5909)</p> <p>Button should go to ON when button is pushed.</p> <div style="border: 1px solid black; padding: 5px; width: fit-content; margin: 10px auto;"> <p style="text-align: center; color: white; background-color: #006666; margin: 0;">DIAGNOSTICS</p> <p style="text-align: center; margin: 0;">Button Input: On</p> </div> <p>Replace button. A5PB5900</p>	
<p>Button light does not blink</p> 	<p>LED Light bulb itself burned out. It should always blink.</p> <p>Disconnected, loose or broken wires.</p> <p>Faulty button.</p>	<p>Check for 12 Volts DC across lights: Red and Black wires.</p> <p>Check connections from switch to Newgen board. (Cable # AACE5909)</p> <p>Replace button. A5PB5900</p>	

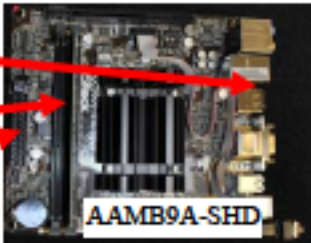
TROUBLESHOOTING GUIDE

Problem	Probable Cause	Remedy
<p>Monitor not working.</p>	<p>Monitor shows "No Signal Detected"</p> 	<p>Monitor HDMI cable unplugged</p> <p>Faulty or loose RAM</p> <p>Large power connector unplugged on motherboard</p> <p>Faulty power supply - Refer to Power Supply diagnostic section</p> <p>Faulty motherboard - Replace faulty board. (AAMB9A-SHD)</p> 
<p>Power down, wait 5 minutes and power up again.</p>	<p>Monitor has nothing at all on power up.</p>	<p>Power cable unplugged from monitor.</p> <p>Faulty monitor.</p> <p>Ensure power is plugged into back of monitor, down to power strip.</p> <p>Replace monitor. (A5MO5500)</p>
<p>Error on screen at power up.</p> <p>Re-Boot game to see if problem still exists.</p>	<p>Display shows "Kernel panic – unable to mount root"</p> <p>Display shows "ASROCK Setup Utility Menu"</p>  <p>Display shows "Ubuntu— Check drive for errors"</p>	<p>Faulty or loose RAM, faulty software, faulty motherboard</p> <p>No SATA drive in motherboard. Check for power connector</p>  <p>Plug in keyboard and press the "F" key. It will check drive for errors and start game.</p>

WIRING DIAGRAMS

AC IN, POWER SUPPLY WIRING

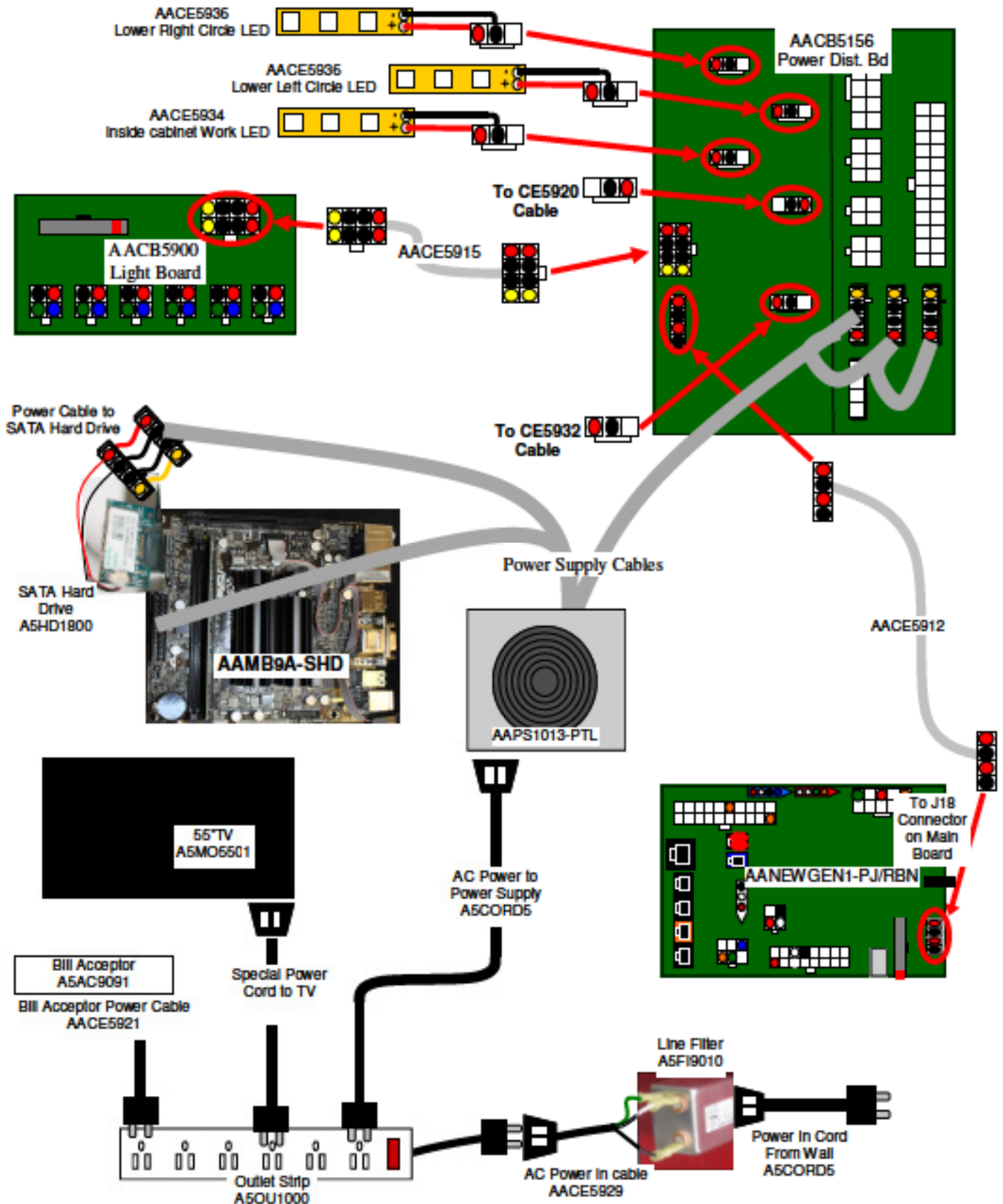

WIRING DIAGRAMS

LIGHT BOARD WIRING

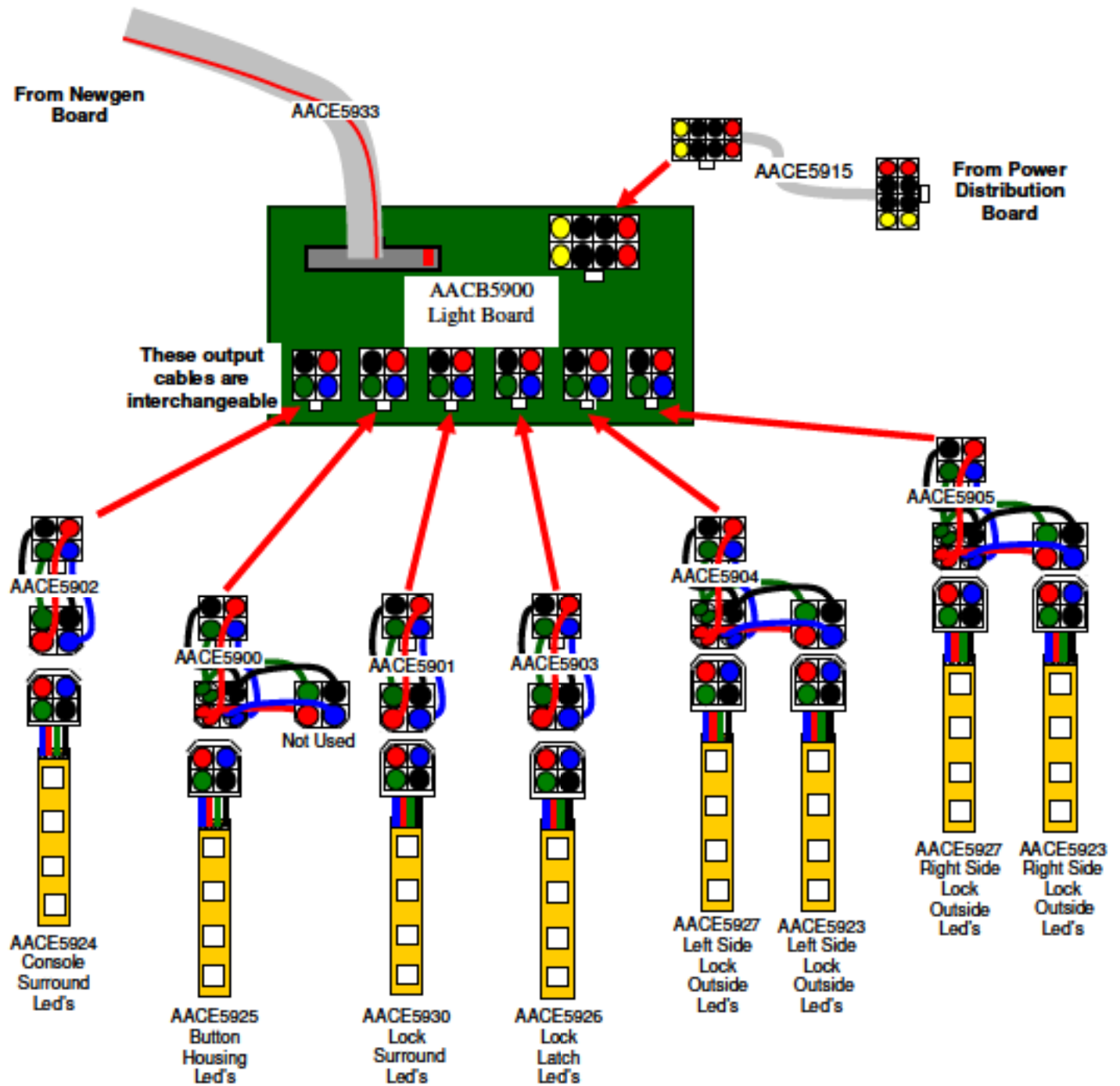

WIRING DIAGRAMS

COIN MECH, MENU & COUNTERS WIRING

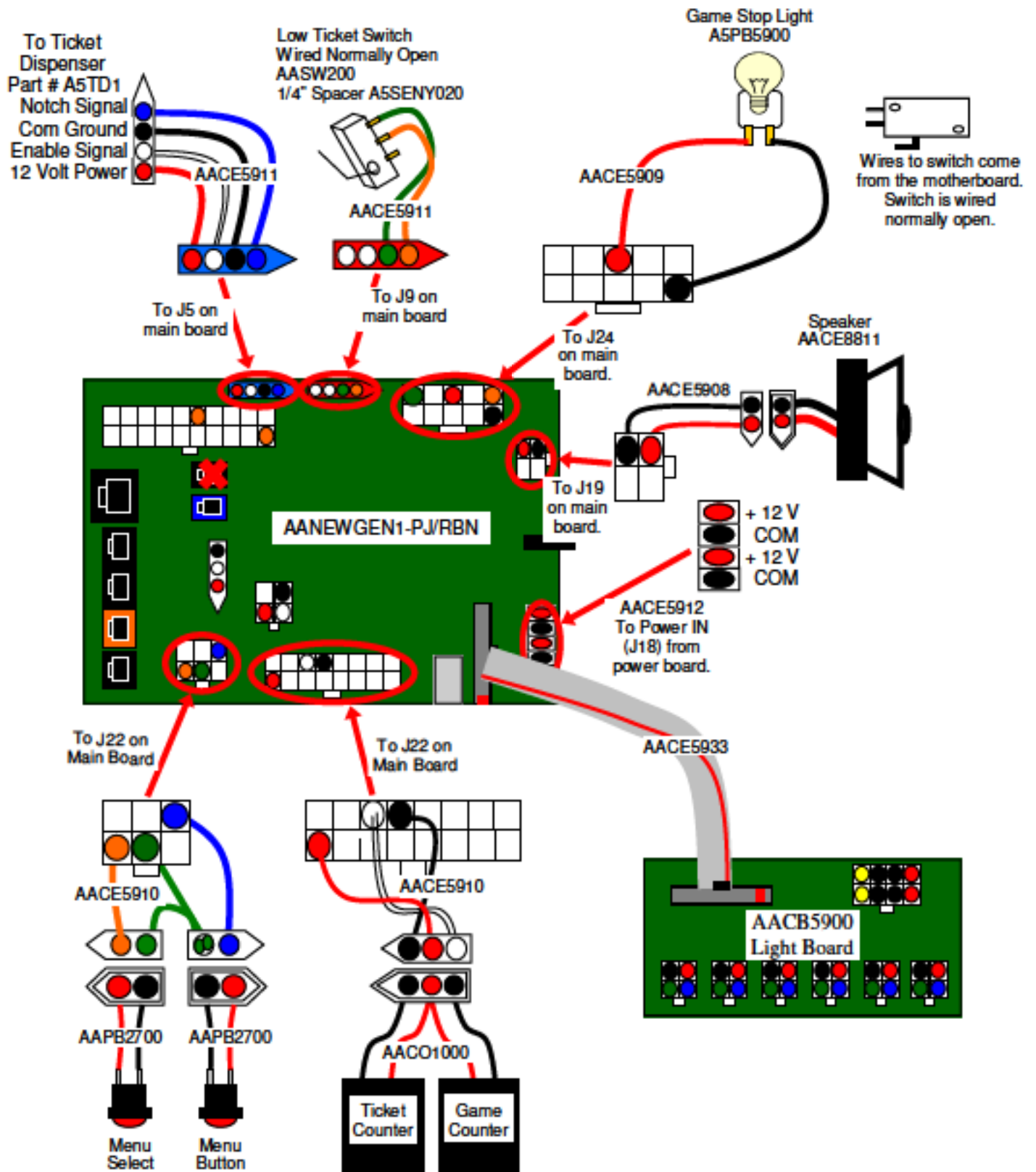

WIRING DIAGRAMS

COIN MECH, MENU & COUNTERS WIRING

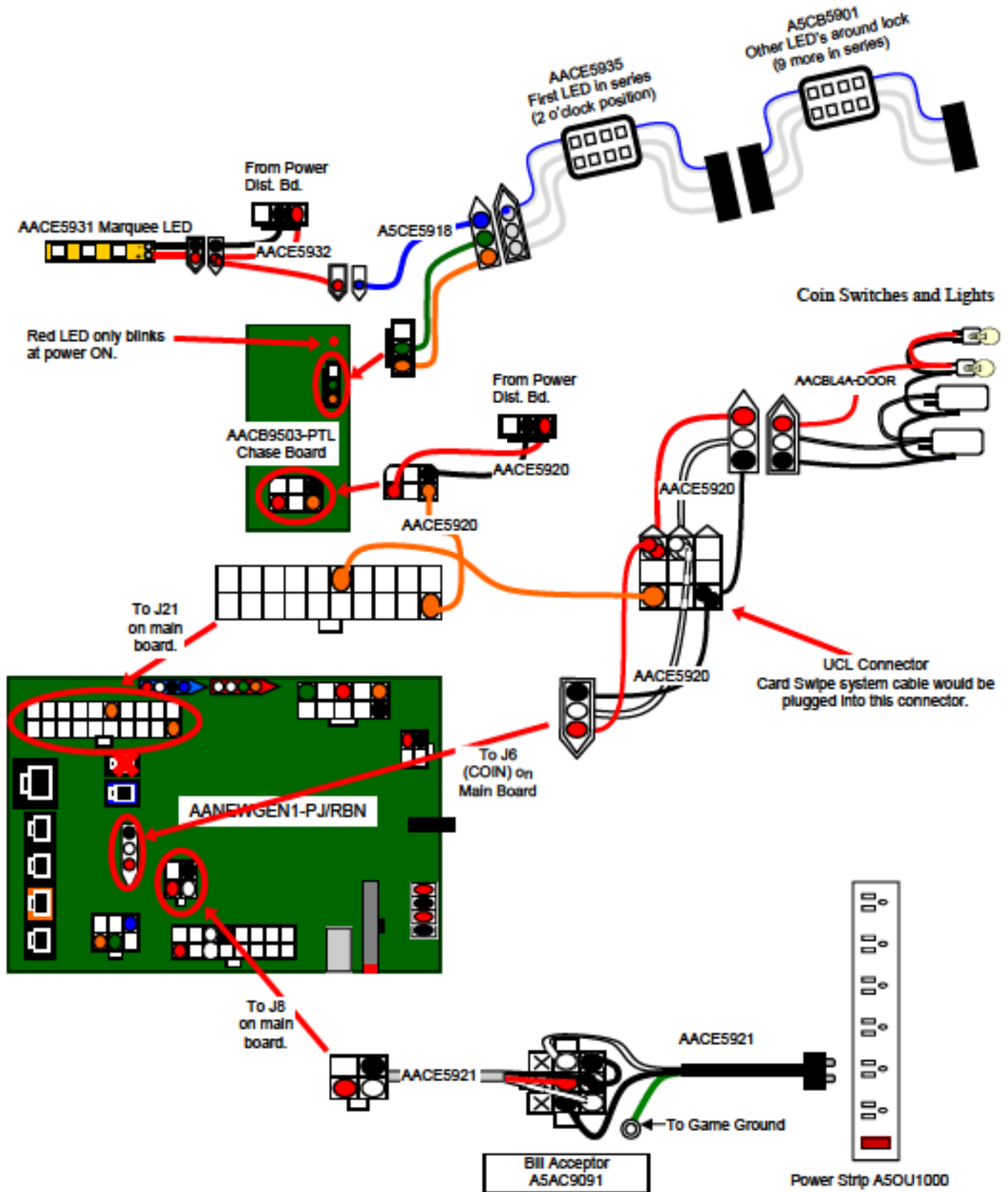

WIRING DIAGRAMS

MOTHER BOARD COMMUNICATION WIRING

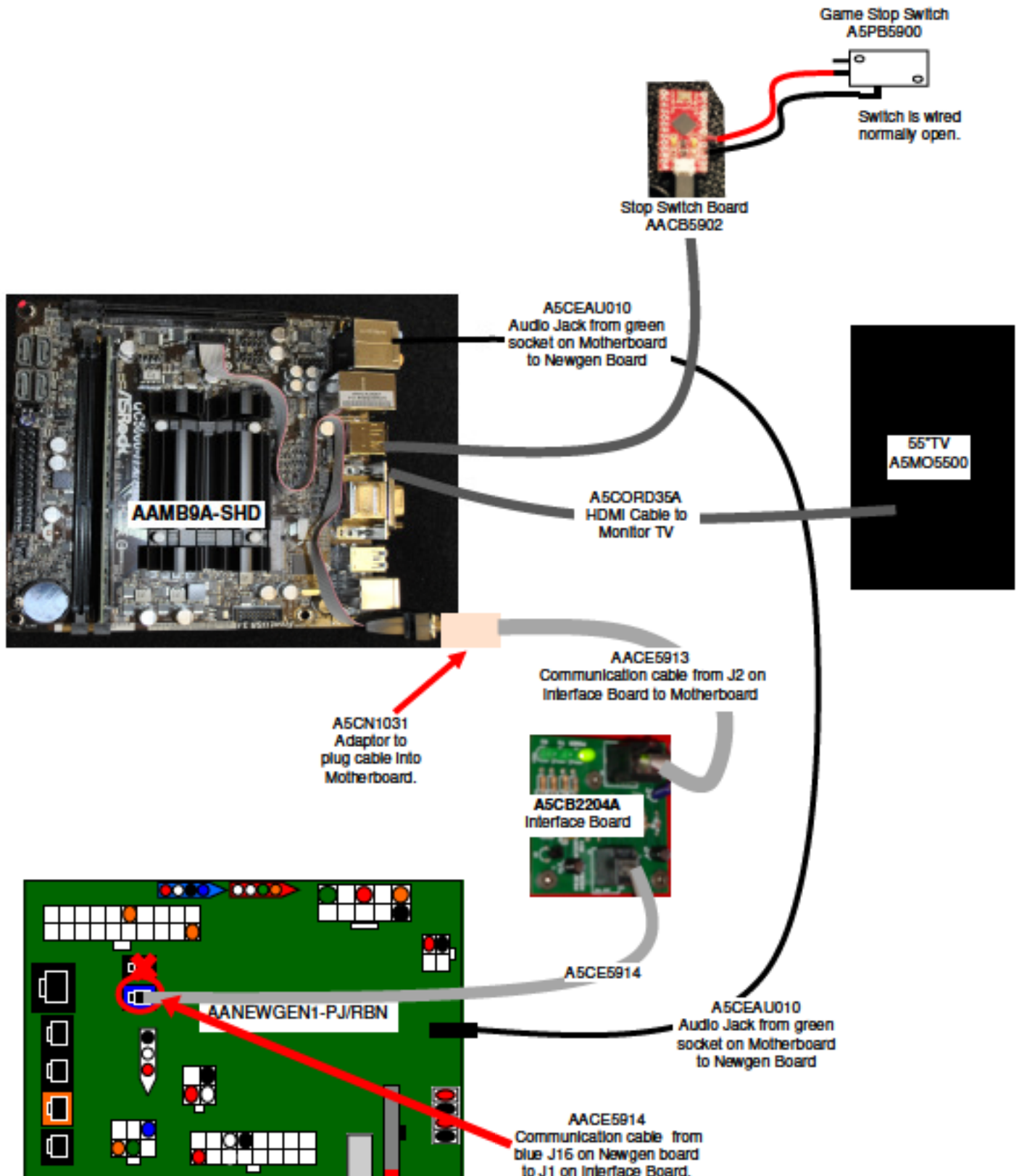

POWER SUPPLY DIAGNOSTICS

1.) Verify AC power to game. Check power strip in front door. The rocker switch should be illuminated.



2.) Check connection to power supply.

3.) Ensure Power Supply switch is set to 115V (or 230V)
(Some model power supplies may not have this)



4.) Ensure Power switch is on.

5.) Ensure fan is turning.

- If power supply fan is turning and there is no 12 Volt out:

Check power supply cables to the Power Distribution Board.

This board takes the power in, and directs it to the different 12 volt loads.

Replace power supply if this board is not receiving 12 volts. (AAPS1013-PTL)

- If power supply fan is not turning, then continue to "Verify Power to Motherboard"

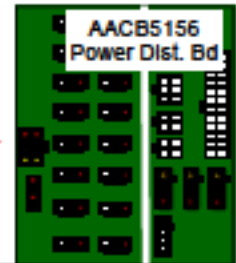

Verify Power to Motherboard

The motherboard will turn on power supply.

If your game has no 12 volts, it may be the motherboard not turning on.

Also - there may be a 12 volt short somewhere in cabinet that is not allowing the power supply to turn on.

Minimize load on power supply and isolate short

Unplug the power supply cables going to the Power Distribution Board.

This will leave the power supply, motherboard, and monitor left plugged in together.

If power supply, motherboard, and monitor now turn on:

Plug in the Power Distribution Board to power supply, but unplug all of the outputs from the board.

Turn on game and verify the 12 volts is good.

Then plug in one component at a time to power supply to locate short.

If power supply still does not power on, then continue to steps 1,2, and 3.

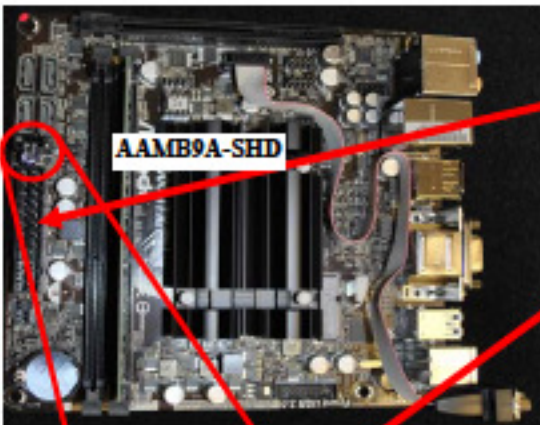

1 - Check single connection from power supply.

2 - Verify these pins are covered by connector with a single capacitor.

If the connector is missing, continue to step 3 to jump the pins under this connector.

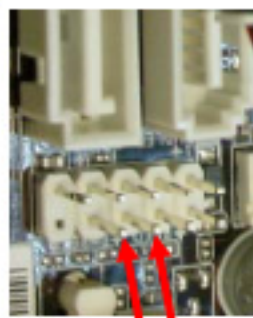

3 - Motherboard "Jump Start"

As a last resort, you may start motherboard by quickly touching these 2 pins at the same time, then quickly release

Motherboard may turn ON and boot normally.

If power supply still does not power on, replace power supply (AAPS1013-PTL), or replace motherboard. (AAMB9-SHD)

DBA DIAGNOSTICS

Note: There are many different models and brands of Bill Acceptors that are used on redemption games. Your Bill Acceptor may differ from the unit shown.
 Standard DBA is MEI # AE2451-U5E Part # A5AC9091

Determine if Bill Acceptor has power:

Turn game ON—The bill acceptor should make noise as stacker cycles and green lights on outside bezel should flash.

If NO power:

Use meter to measure 110 AC voltage at cable going into Bill Acceptor from power strip.

If power is OK:

Clean Bill Acceptor path to make sure there is nothing jamming unit.

Check dipswitch settings on side of acceptor.

Make sure switch # 8 is OFF for Always Enable



ERROR CODES

Count the number of flashes on front bezel of Bill Acceptor and follow chart for repair.

REMOVING MAGAZINE
 Push latch on acceptor forward.
 Slide magazine toward latch and pull away from acceptor.

COUPON SETUP
 Coupon recognition requires all switches to be OFF.
 Press ● on rear of LED cartridge to enter coupon mode.
 Insert completed coupon. LED will flash 10 times upon successful completion.

DIAGNOSTICS (RED LED LOCATED ON REAR OF LED CARTRIDGE)

# FLASHES	STATUS
1	bill path jammed
2	disabled from system
3	needs cleaning
4	cross channel blocked
5	magazine removed
continuous, slow	unit failure; replace unit
continuous, fast	stacker full

CLEANING THE BILL PATH
 Separate the metal bar and...
 Remove both LED cartridge...
 magazine for full bill path...

FOR TECHNICAL SUPPORT CALL: 1-800-345-8172

PARTS LIST

PART #	DESCRIPTION	PART #	DESCRIPTION
A5ME5900	METAL,BOTTOM RAIL	AACE5900	CABLE ASSY, CONTROL PANEL LIGHT
A5BK1013	BRACKET,PUSHBUTTON/COUNTERS	AACE5901	CABLE ASSY, LOCK SURROUND LEDS
A5BK6035	BRACKET,LIGHT	AACE5902	CABLE ASSY, BOTTOM LIGHT HOLDER
A5CB1499	COIN BOX	AACE5903	CABLE ASSY, LOCK LATCH LEDS
A5CN1031	CONN,ADAPTER 9POS F-RJ45	AACE5904	CABLE ASSY, LEFT SIDE LIGHTS
A5CO4203	COVER,SPEAKER	AACE5905	CABLE ASSY, RIGHT SIDE LIGHT
A5CORD5	CORD,AC COMPUTER CORD	AACE5908	CABLE ASSY, SPEAKER CABLE
A5DE0042	DECAL, NEW MENU/VOLUME POT	AACE5909	CABLE ASSY, BUTTON SWITCH LIGHT
A5DE0048	DECAL, UNIVERSAL CARD LINK	AACE5910	CABLE ASSY, MENU & COUNTER CABLE
A5DE0114	DECAL,CIRCLED GROUND STUD	AACE5911	CABLE ASSY, TICKET TRAY CABLE
A5FI9010	FILTER,INLINE,TO PASS FCC	AACE5912	CABLE ASSY, POWER SUPPLY CABLE
A5LK2001	LOCK, CASH BOX, A05/E00 KEY	AACE5913	CABLE ASSY, COMMUN. CABLE
A5LK5002	LOCK, 7/8", H95 KEY CODE	AACE5914	CABLE ASSY, POWER COMMUN. CABLE
A5PB5900	PUSH BUTTON,RED,W/LEDS	AAPB2700	PUSHBUTTON ASSY
A5SW200	LOW TICKET SWITCH	AACO1000	COUNTER_ASSY
A5TD1	TICKET DISPENSER,ENTROPY	A5CEAU010	CABLE,AUDIO STEREO,3.5MM
A5TT4000	TICKET TRAY	AAPS1013-PTL	POWER SUPPLY ASSEMBLY
A5VF5901	VACUUM FORM,PLAYFIELD	A5CBL4A-DOOR	CABLE, DOUBLE COIN DOOR
A5VF5902	VACUUM FORM,HASP	AACE5915	CABLE ASSY, POWER CABLE TO LIGHT BD
A5VF5903	VACUUM FORM,BUTTON HOUSING	AACE5916	CABLE ASSY, GROUND WIRE
A5MO5501	MONITOR/TV,55"	AACE5918	CABLE ASSY, LIGHT BOARD JUMPER
A5PL8900	PLATE,BLANK,BILL VALIDATOR	AACE5920	CABLE ASSY,ADDRESSABLE LED LIGHT
A5OU1000	OUTLET,STRIP,SIX,15AMP,125V	AACE5921	CABLE ASSY, DBA CABLE
A5CORD35A	CORD,15",HDMI W/FERRITE CORES	AACE5923	CABLE, INSIDE SIDE LOCKS TO HASP,LED
A5DE5900	DECAL,BUTTON BASE	AACE5924	CABLE ASSY, CONTROL PANEL LED
A5DE5901	DECAL,CONTROL PANEL	AACE5925	CABLE ASSY, BUTTON CABLE LED
A5DE5902	DECAL,CABINET FRONT	AACE5926	CABLE ASSY, MARQUEE LED LIGHTS
A5DE5903	DECAL,MECH DOOR	AACE5927	CABLE ASSY, OUTSIDE SIDE LOCK LED
A5DE5904	DECAL,COIN DOOR	AACE5929	CABLE ASSY, LINE FILTER JUMPER
A5DE5905	DECAL,SIDE LOCK	AACE5930	CABLE ASSY, PLAYFIELD LIGHT
A5DE5907-R	DECAL,RIGHT,CAB SIDE	AACE5931	CABLE ASSY, MARQUEE SIDE LIGHT
A5DE5907-L	DECAL,LEFT,CAB SIDE	AACE5932	CABLE ASSY, MARQUEE POWER CABLE
A5DE5908	DECAL,JACKPOT WINDOW	AACE1715	CABLE ASSY,GROUND STRAP
A5DE5909	DECAL,MARQUEE ACRYLIC	AACE5933	CABLE ASSY, MINI GEN TO LIGHT BD RBN
A5DE5911	DECAL,LOCK FACE	AACE5934	CABLE ASSY, SERVICE LIGHT
A5DE5912	DECAL,LIGHT DIFFUSER	AACE5935	CABLE ASSY, FIRST NOTCH LIGHT BOARD
A5TR2800	TRIM,RUBBER EDGE,FOR MARQUEE	AACE5936	CABLE ASSY, SIDE CABINET LIGHTS
W5HG1035	HINGE,23",DOUBLE BEND	AACB5900	CIRCUIT BD, LIGHT CNTRL
W5KE5000	KEEPER,LOCK	A5CB2204A	CIRCUIT BD, SERIAL COMM
A5CA1005	CASTER,250# LOAD,SWIVEL/LOCK	AACE8811	CABLE ASSY,SPEAKER
W5HG1025	HINGE,16",DOUBLE BEND	AAMB9A-SHD	MOTHERBOARD W/16G SATA
W5HG1045	HINGE,5.75" DOUBLE BEND	AANEWGENT-P1/RBN	BD ASSY,MINIGEN,W/PHONO JACK&RIBBON
W5TM4000	T-MOLD,7/8"BLACK	AACB5156	CIRCUIT BD, POWER DISTRIBUTION
A5CL1004	CLAMP,VERSA LATCH	AACB9503-PTL	CIRCUIT BOARD ASSY, CHASE BOARD,
		A5CB5901	CIRCUIT BOARD,NOTCH LED BOARD

PARTS PICTURES



A5PL9097



A5CA1002



A5VF2002



A5CE1801



A5CN1031



A5CEAU010



A5CORD11



A5CORD23



A5CORD5



A5FI9010



A5OU1000



A5LK2000



A5LK5001



A5PS1008



A5CN1031



AACBL4A-DOOR



AACE8811



AAPB2700



A5CB2204A



AAMB9A-SHD



AANEWGEN1-PJ/RBN

DECALS DIAGRAM



Pop the Lock

DECAL DIAGRAM

MARQUEE

- ASDES909_MARQUEE ACRYLIC
- ASDES908_MARQUEE BACKGROUND

- ASDES911_LOCK FACE DECAL (5/GAME)
- ASDES912_LIGHT DIFFUSER (10/GAME)
LOCATED UNDERNEATH ASDES911

- ASDES900_BUTTON BASE DECAL
- ASDES901_CONTROL PANEL

- ASDES907-L_CABINET SIDE LEFT
- ASDES907-R_CABINET SIDE RIGHT
NOT VISIBLE IN PICTURE

- ASDES905_SIDE LOCK GRAPHIC (2/GAME)

FRONT CABINET

- ASDES902_CABINET FRONT
- ASDES903_MECHDOOR
- ASDES904_COINDOOR



TECHNICAL SUPPORT

Excellent customer service is very important to Bay Tek Games!

We know that keeping your games in great operating condition is important to your business. When you need us, we are here to help. You can call us for free technical assistance, and you can count on us to have parts on-hand to support your game. We offer options that fit your needs.

Electronics / Circuit Boards - Repair Options

Repair & Return – If you have Circuit Board issues with your Bay Tek game, you can send the board to us and we'll repair it right away. Most items sent to us are repaired and returned to you within two days. This option is your best value as we offer this fast turn-around service at the most reasonable price.

Advance Replacement – If you have Circuit Board issues with your Bay Tek game, but you don't have time to send in your board in for repair, give us a call and ask for an Advance Replacement. We'll send you a replacement board that same day (pending availability). When you get your new board, just repackage the defective board in the same box and send it back to us. We make it easy by including a UPS Return Shipping label for you to put on the box (not available for international shipments). This is your best option when you need to get your game up and running as quickly as possible!

Spare Parts – Take matters into your own hands and purchase new spare Circuit Boards for your Bay Tek games. Many of our games share the same main-board electronics. This means you can buy one set of spare electronics to support many of your Bay Tek games. Spare boards allow you to get your game up and running the quickest and provide you a valuable troubleshooting option. Call our technicians to get recommendations for what you should keep on hand for spare parts!

Technical Support:

"You" are the best tool for troubleshooting! Your abilities to understand the game and your skills to repair the game are invaluable to us! If you need help, you know you can call us. It's not easy to diagnose a game remotely by phone, but our technicians do a great job. They'll need your help to perform some troubleshooting steps and convey to them exactly what's happening with your game.

Returns, Credits, & Fees:

NOTICE! ALL ITEMS being sent to Bay Tek Games for repair or return, etc. require prior Return Authorization! Bay Tek Games will provide a Product Return Form with an authorizing Ticket Number for each item to be returned. Please be certain to include this document with all shipments!

Late Fees and Non-Return Fees - Advance Replacement and Warranty Replacement items require the defective items to be returned by Bay Tek games promptly to avoid Late Fees. We expect items to be returned with 10 working days. Late fees are invoiced monthly. Late fees are non-refundable under any circumstance! Any item not returned within 90 days will be invoiced in full as a replacement part.

Bench Fees - Bench fees will apply for each electronic item returned to Bay Tek Games (this includes unused Advance Replacement items). This charge covers our cost to inspect, evaluate and retest each item. Please note that returned items that do not pass our tests will be charged accordingly as replacement items or advance replacements.

Restocking Fees - Unused items returned for credit will be credited minus a restocking fee. Items must be returned within 30 days of purchase in order to qualify for any credit amount. No shipping charges will be credited.